Installation & Operation Manual

Full Inverter Swimming Pool Heat Pump









Thank you very much for purchasing our product, please keep and read this manual carefully before you install the heat pump.

Unit Installed by: _____

Unit Install date: _____

Unit Serial Number: _____

Packing List

No.	Name	Qty.	Remark
1	Installation & Operation Manual	1	
2	Wire-controller	1	
3	Wire controller box and sponge pad (to be installed on the heat pump shell)	1	
4	Drain-pipe (2 m)	1	
5	Drain-pipe connector	1	
6	Rubber shock absorber	4	
7	Heat Pump Unit (The pipe connector has been installed on the machine)	1	

Please keep installation manual safe and read it carefully before using.

 The unit must be installed by professional personnel according to the instructions in this manual and in accordance with AS5352:2002 SWIMMING POOL HEAT PUMP SYSTEMS.

 **WARNING:** We recommend that the unit be protected from the risk of lightning strikes or power fluctuations by installing surge protection measures.

 **WARNING:** (Northern Hemisphere only) The unit is not suitable for use in winter: all water must be drained from the unit during winterization or it could freeze inside the unit causing damage to the internal components.

Table of Contents

1. Accessories.....	
2. Safety.....	
3. Do's & Dont's	
4. Heat pump unit working principle.....	
5. Installation of the unit.....	
6. Installation of the pipeline.....	
7. Installation of optional accessories.....	
8. Installation and operation of electric devices.....	
9. Operation Instructions.....	
10. Exploded View.....	
11. Wireless/Remote control.....	
12. Adjusting and Initial operation.....	
13. Operation and maintenance.....	
14. Fault analysis and elimination method.....	
15. Technical parameters.....	
16. After-sale service.....	
17. Warranty.....	

1. Accessories

Each unit produced by our factory comes with the following accessories:

No.	Name	Qty.	Use
1	Installation & Operation Manual	1 PC	User Guide to install the unit
2	Wire controller	1 PC	Used for the machine operation interface
3	Drain-pipe	1 PC	Used for draining the condensate water
4	Drain-pipe connector	1 PC	To connect the drain pipe to the heat pump
5	Rubber shock absorber	4 PCS	To reduce vibration and noise
6	Heat pump unit	1 SET	For heating water

In order for the system to work the following parts are required

No.	Name	Qty.	use
1	Water pump	1	To circulate the pool water
2	Filter system	1	To clean the pool water which passes through the heat pumps
3	Water pipes system	1	To connect the equipment and circulate the water in the pool

NOTE

The types and quantity of the water pipes, valves, filter equipment, sterilizing equipment used for the swimming pool heating/circulation pipe system, depend on the project design. We do not recommend to install auxiliary electric heaters in the system.

2. Safety

Range of application:

1. Power supply: 220V-240V/1N~50Hz.
2. Ambient temperature: -15°C~43°C :
3. Working water temperature: Min. inlet water temperature 8°C, Max. outlet Water Temperature 40°C. If the system is always used beyond the available water range, please contact with manufacturer.



THE UNIT MUST BE EARTHED PROPERLY BEFORE USAGE

- The installation should be done by a professional person, to prevent leaking, electric shock or fire in accordance to AS/NZS3000, Electrical Installations.
- Confirm the ground connection, if the ground connection is not correctly done, it may cause electric shock.
- We do not recommend that the unit be installed in an enclosed room or any other form of enclosure. Enclosing the unit may affect the performance and lead to costly running expenses.
- If the heat pump is installed in a small room, make sure it is well ventilated, warm air needs to be brought into the room and cold air created by the heat pump needs to be removed from the room. If the unit is allowed to recirculate its own cold air the unit efficiencies will be affected.
- Don't put fingers or objects into the air inlet outlet as the rotating fan could cause serious injuries.
- If you smell anything burning, turn off the manual power switch immediately, stop operation and contact the after-sale service department. Continued abnormal operation may cause electric shock fire.

-
- When the unit needs to be removed or re-installed, please ensure that the work is carried out by qualified professionals. If the installation is not correct, it may cause unit operation failure, electric shock, fire, hurt, leaking, etc.
 - Please ensure that any repairs carried out by qualified professionals: failure to make proper repairs could cause unit operation failure, electric shock, fire, hurt, leaking, etc..
 - Do not install the unit near flammable sources, as any leakages could cause a fire.
 - Make sure the base on which the unit is installed is strong enough to support it.
 - Make sure a leakage protection switch is installed to prevent electric shock or fire.
 - When cleaning the unit, stop operation, switch off the power and disconnect the power.

3. DO's and DON'Ts

DO's:

- Keep your pool chemicals away from the heat pump.
- Keep area clear around heat pump, especially around the fan discharge.
- Regularly clean with a microfibre cloth and water.
- Use surface spray around perimeter of the machine regularly to deter insects
 - Brush away spider webs if apparent.
- Keep condensation line below the level of the heat pump and ensure good drainage.
- Book annual services to maintain performance.

DONT's:

- Do NOT enclose the unit – this will restrict performance.
- Do NOT use cleaning agents or scourers to clean the heat pump.
- Do NOT leave the controller/touch pad exposed to weather (e.g. rain or water), keep the touch pad inside its protective shroud when not in use.
- Do NOT attempt any repairs as this can void warranty – Contact Green Star Solutions.
- Ensure your heat pump is NOT installed directly against a fence or wall.
- Ensure your heat pump is NOT installed within 1.5m of a gas appliance (e.g. gas hot water system).

Contact Green Star directly with any queries or service needs **08 9331 3868** or **service@greenstarsolutions.net.au**

4. Heat pump unit working principle

4.1 Heat pump operation

Heat pumps use heat from the sun by collecting and absorbing energy from the outside air. This energy is then compressed and transferred to the pool water. Your existing water pump circulates the water through the heat pump, which is normally installed next to the pool filtration system, and the water warms up. The heat pump timer can be set so that the pump operates at the times you want: for example, during daylight hours from 9am to 5pm.

- The unit contains a fan that draws in outside air and directs it over the surface of the EVAPORATOR (energy collector). The liquid refrigerant inside the EVAPORATOR coil absorbs the heat from the outside air and becomes a gas.
- The warm gas inside the coil passes through the COMPRESSOR, which concentrates and increases the heat to form a very hot gas, which then passes through the CONDENSER (water heat exchanger). It is here that the heat exchange occurs as the heat from the hot gas is transferred to the cool swimming pool water circulating through the heat exchanger.
- The pool water becomes warmer and the hot gas returns to its liquid form as it flows through the CONDENSER coil. The gas then passes through the Electronic Expansion Valve and the whole process begins again.
- Developments in heat pump technology mean that today heat pumps can efficiently collect heat from the outside air even when the temperature is as low as 7-10°C. This means that for tropical and subtropical climates the pool can be maintained between 26°C and 32°C.

4.2 Air source heat pump working principle

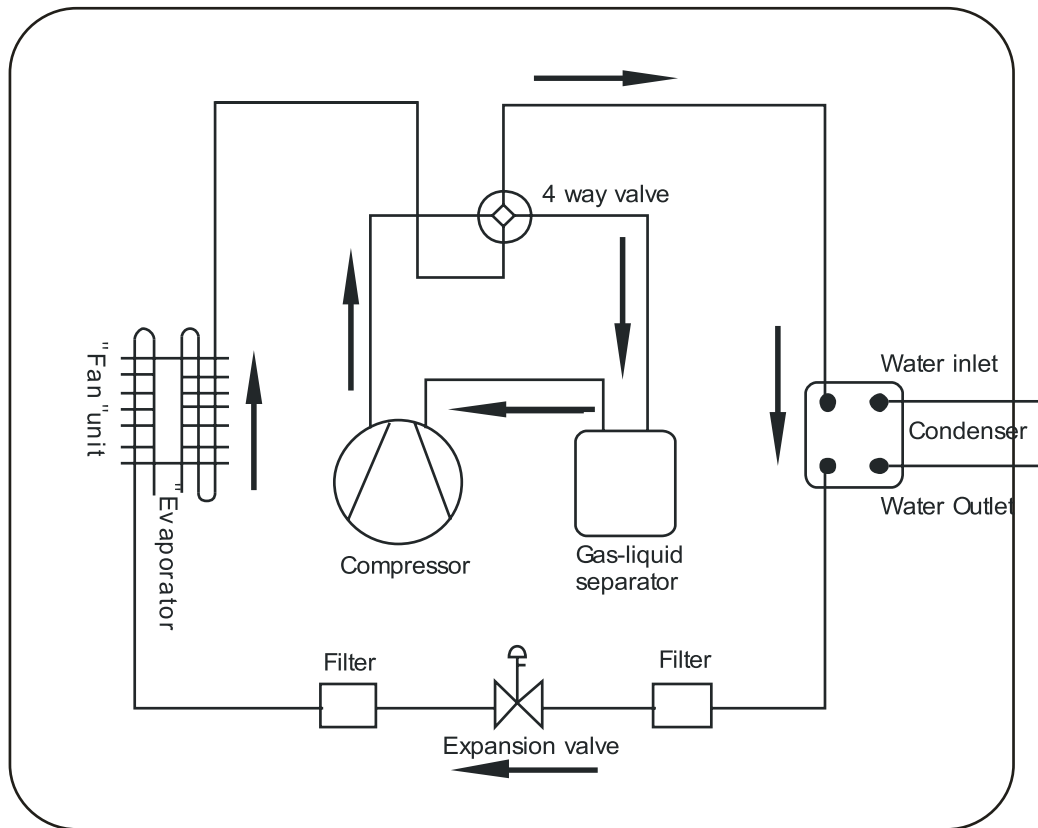

Figure 1

Q_c (Heat energy) = Q_a (Compressor consumption) + Q_b (Heat energy absorbed from ambient environment)

5. Installation of the unit

5.1 Installation Guidelines

- Avoid installations in locations containing mineral oil.
- Avoid installation in locations where the air contains salt or other corrosive gases.
- Avoid installation in locations with serious power supply voltage fluctuation.
- Avoid installation in unstable places, such as a car or cabin.
- Avoid installation near flammable items.
- Avoid installation in locations with strong electromagnetic forces.
- Avoid installation in locations with harsh environmental conditions.
- Avoid installation of the machine within 2 mtrs or less from a forced water ingress point - for example, a reticulation/sprinkler head.
- Ensure that the unit is installed in accordance to AS5352:2022 SWIMMING POOL HEAT PUMP SYSTEMS.
- Failure to follow these guidelines may void warranty.

5.2 Installation check

- Check the model, number, name etc, to avoid incorrect installation.
- Make sure there is enough space for installation and maintenance.
- Install in a dry, well-ventilated place ensuring there are no forced water ingress points (like a reticulation/sprinkler head) near the unit and make sure there are no obstructions around the air intake and outlet points.
- Ensure the rubber shock absorber pads are installed and the condensation drain is attached, has a gradual fall and is accessible. As this will need regular checkups/inspections for any blockages or debris build ups.
- Make sure the unit is installed as per the ventilation diagram to ensure efficient heating rates.
- Make sure the supporting base is strong enough and prepared to that shocks can be avoided.
- The power supply and diameter of the cables used must be in accordance with the electrical installation requirements, to AS/NZS3000 Electrical Installations.
- Electrical installation must comply with the relevant technical standards of electrical equipment, and electrical insulation work must be done.
- The unit must be put horizontally for at least eight hours before running.

5.3 Installation space

Please observe the space requirements indicated below for optimal operation and maintenance.

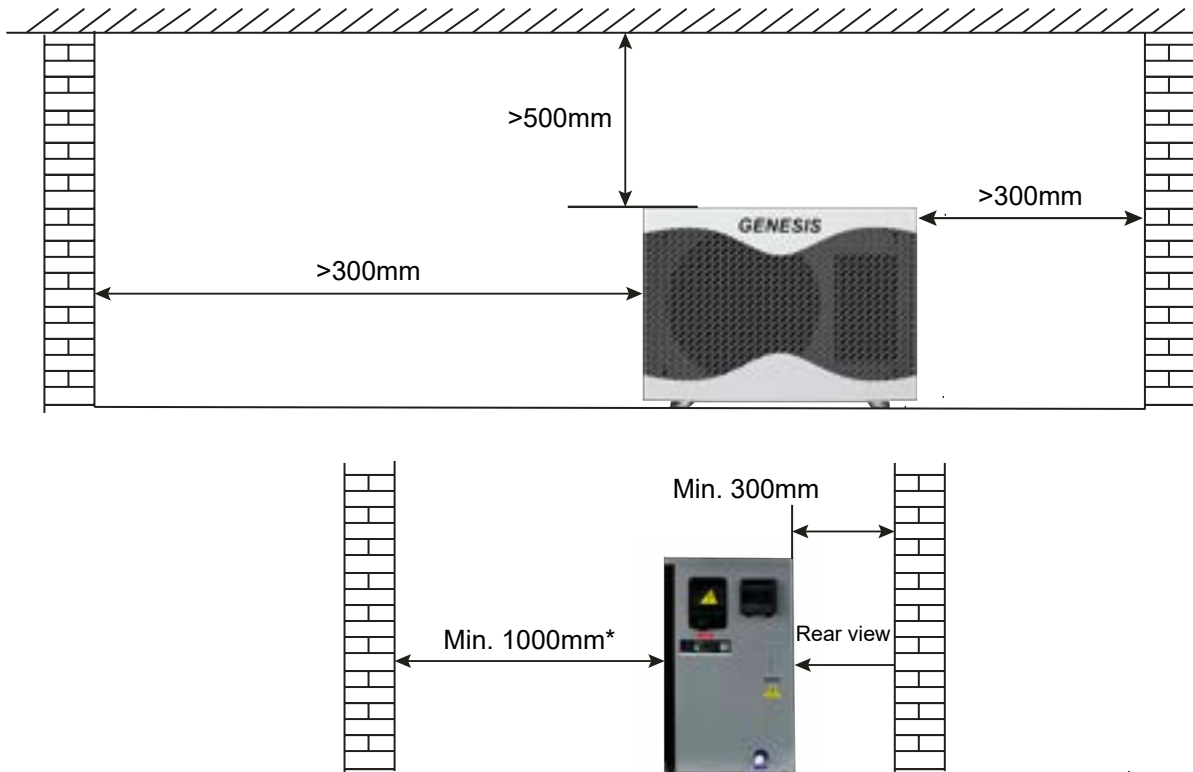

Figure 3. Horizontal installation space requirements (mm)

*We recommend 2000mm or greater.

5.4 Heat pump dimensions

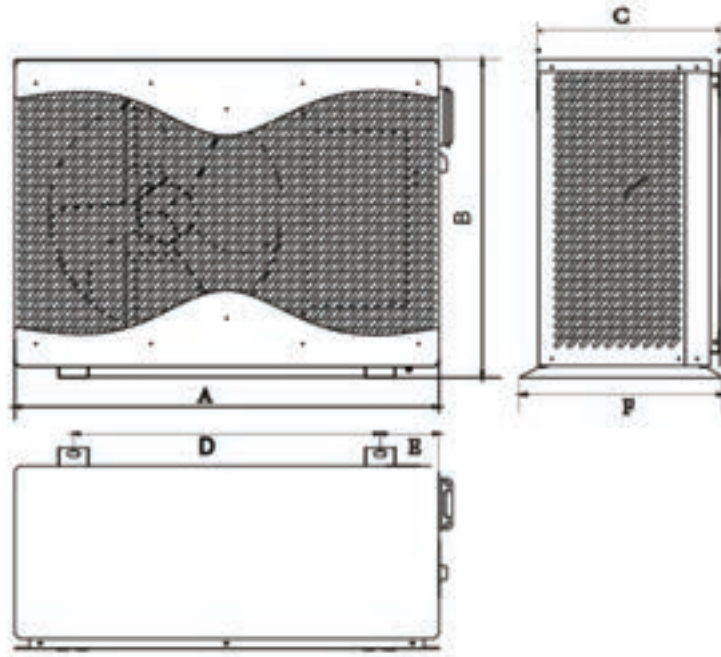

Figure 4 Heat pump dimensions

Size(mm) Model No.	A	B	C	D	E	F
BYC-007TG1 BYC-010TG1	821	587	362	474	173	405
BYC-013TG1 BYC-017TG1 BYC-021TG1	850	637	366	614	118	405

5.5 Lifting

- Please use four or more soft lifting belts to move the sets (see Figure 6).
- Please use protective plates on the surface of the units when handling to avoid scratches and deformation.
- Double-check that the support base is strong enough before fixing the unit.
- The heat pump will produce condensation water: remember to provide a drainage channel when making the installation base.
- Please install shock absorbers on the surface of the base.

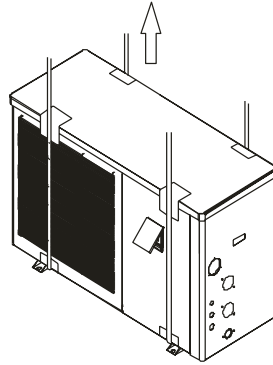

Figure 6 Lifting diagram













6. Installation of pipes

6.1 Attention

- Prevent air, dust and other material from going into the water pipes.
- Fix the whole system before installing the water pipes.
- Water inlet and outlet pipes should be protected by an insulation layer.
- Make sure that there is a stable water flow, to prevent excessive throttling.
- Do not handle, move or lift the unit by holding the water inlet and outlet pipe: use only the holes on the beam of the base (see Figure 9)

6.2 Instructions

6.2.1 Symbols

												
Valve	Filter	Flexible connection	Check valve	Pump	Air valve	Pressure gage	Flow switch	Feeding tank	Flared joint	Hair collector	Sand Filter	Chemical dosing system

6.2.2 Pipeline installation diagram

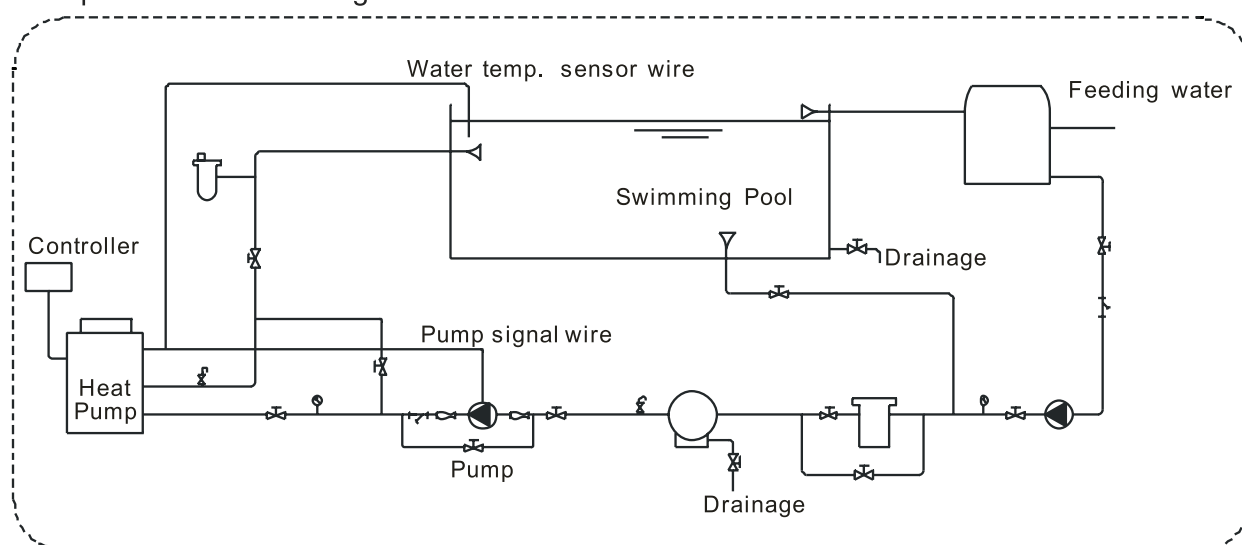

Figure 8 Diagram (Single unit for reference)

- It is recommended to install a one-way valve for each unit to prevent water back flow.
- Multiple units can be installed as part of a system, but each unit should be controlled independently.
- All pipes and valves should be insulated.

6.2.3 Installation options:

1. Inline with Filtration

The heat pump is activated by the flow of water initiated from the filtration/circulation pump, if the heater gets to temperature within the timers the unit will first start to use the inverter technology to slow the machine down to maintain the temperature and eventually to a stop.

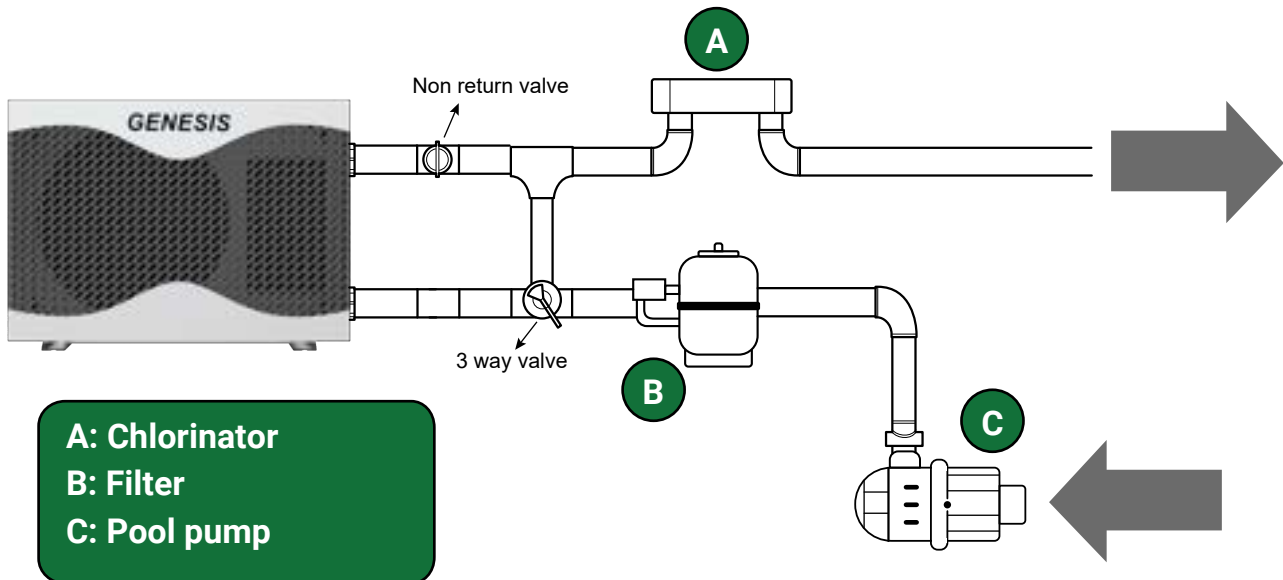

1. Chlorinator controller initiates the filtration pump either manually or through a timer.
2. Heat pump's flow switch senses the water flowing through the heat pump.
3. Heat pump starts and will run until temperature is reached or filtration pump switches off
4. No additional settings needed to be changed.
5. If the circulation pump is not running and no flow is detected, the unit will display E25 – this is normal and an indication the unit is sitting idle waiting for the filtration pump to start again.
6. If the pool temperature is not reached within the filtration times you may need to extend the timers to match the heating requirement.

2. Independent Install

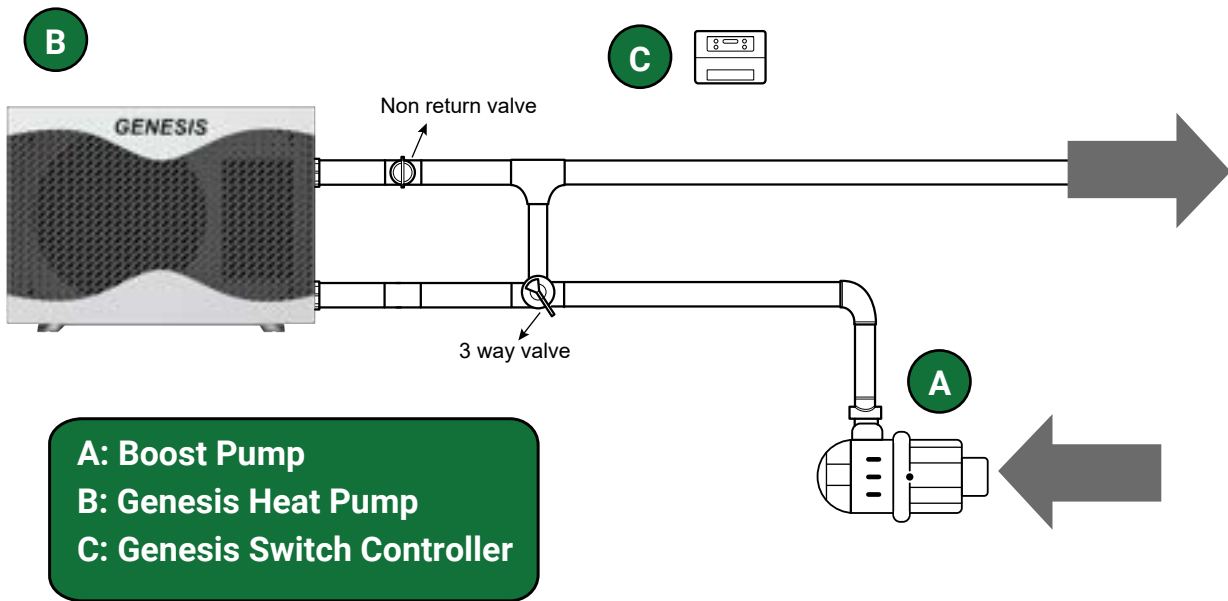

1- See Boost Pump installation manual for more information on commissioning and how to set the pump.
(pump should be in normally off state for activated control)

2- Once temperature is reached or the timer is finished the heat pump will switch off the relay output stopping the circulation pump.

3- If the pool reaches temperature but the timer is still active the heat pump will switch off the relay to stop the circulation pump.

6.2.4 Connection sizes

Model No.	Inlet	Outlet
GENESIS-007KW-TG1 GENESIS-010KW-TG1 GENESIS-013KW-TG1 GENESIS-017KW-TG1 GENESIS-021KW-TG1 GENESIS-030KW-TG1	DN40	DN40

- The pipe pressure and flow rate should be calculated before selecting the diameter of the pipe, pressure drop range is 0.3~0.5 kgf/cm²(3~5m) head pipe flow rate range is 1.2~2.5 m/s.

- The hydraulic calculation should be made after selecting the pipe diameter. If the resistance is more than the pump head, then a more powerful pump or larger pipes are required.

6.2.5 Required Water Quality

- Bad quality water will produce more lime scale and sand: this kind of water should be filtered and demineralized.

- The water quality should be analyzed before operating the unit: PH value, conductivity, Chloride ion concentration and sulphate ion concentration should be checked.

- Acceptable water quality shown below:

PH value	Total hardness	Conductivity	Sulphate ion	Chlorine ion	Ammonia ion
7~8.5	< 50ppm	<200μV/cm(25°C)	None	< 50ppm	None
Sulfate ion	Silicon	Iron content	Sodium	Ca	
< 50ppm	< 50ppm	< 0.3ppm	No requirement	< 50ppm	

- Suggested filter mesh = 40.

7. Installation of optional accessories

7.1 Selection of the water pump

- The circulation pump is required for the system to operate, there is a terminal connection for the pump (single phase)

NOTE ⚠ For single-phase pumps, please check the wiring diagram.

- Head of circulation pump = height difference between water level and main unit + total pipeline resistance (determined by the hydraulic calculation) + pressure loss of main unit (see nameplate on heat pump).

NOTE ⚠ Multiple units are installed in parallel place more demand on the water pump requirement.

7.2 Water pipe selection

- The selection of the water pipe should be based on the actual system specifications
- The flow switch can be installed horizontally or vertically. If installed the direction of the water flow must be upwards and NOT downwards.
- The flow switch must be installed on a straight pipeline, and there must be more than five times the length of the pipe diameter on either side of the flow switch (see Figure 9 below). The direction of fluid must follow the arrow on the controller. The terminal block should be installed in a position that is easy to operate.

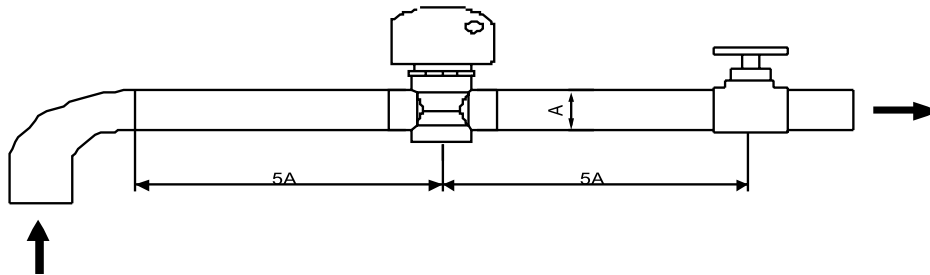

Figure 9

8. Installation of electrical devices

8.1 Electrical wiring

- The unit should have a dedicated power supply in accordance with the recommended voltage.
- Unit power supply circuit must have an effective external grounding.
- Wiring and electrical connections must be made by qualified professionals in accordance with the wiring diagram.
- Power line and signal line layout should be neat and cables should not interfere with each other.
- Do not install the units if the power supply specifications are not met.
- After all wiring connections have been completed, check them again carefully before switching on the power.

8.2 Electrical Wiring Specification

Model	Electrical Wiring Specification
BYC-007TG1 BYC-010TG1 BYC-013TG1 BYC-017TG1 BYC-021TG1	3*2.5 mm ²
Terminal	Terminal cable max. 4 mm ²

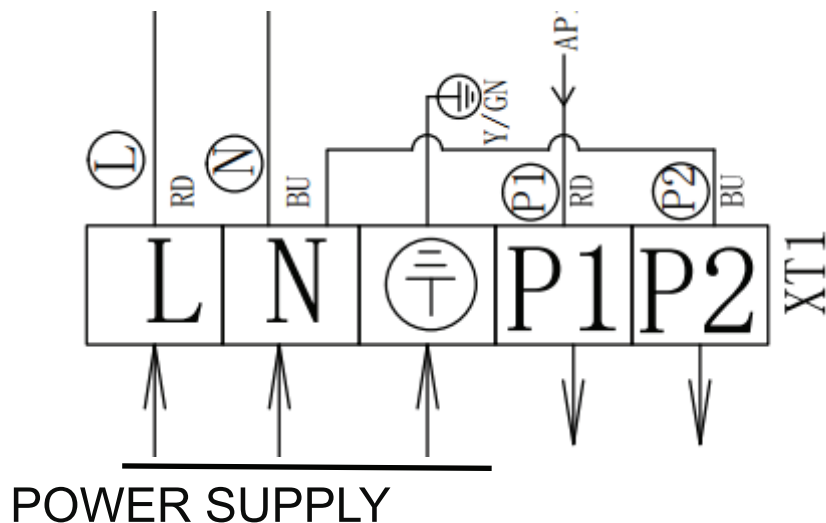
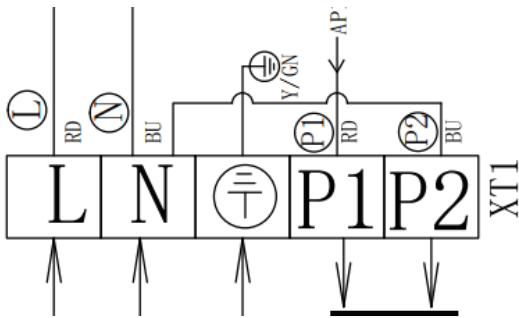

Figure 14

8.3 Circulation pump installation

The heat pump only provides a signal for the circulation pump, A separate A.C. Contactor is required to connect the circulation pump.



NOTE:
Only for signal control, not direct connection to power supply

To water pump
AC 220~240V 50Hz
Maximum 1200W

Figure 15

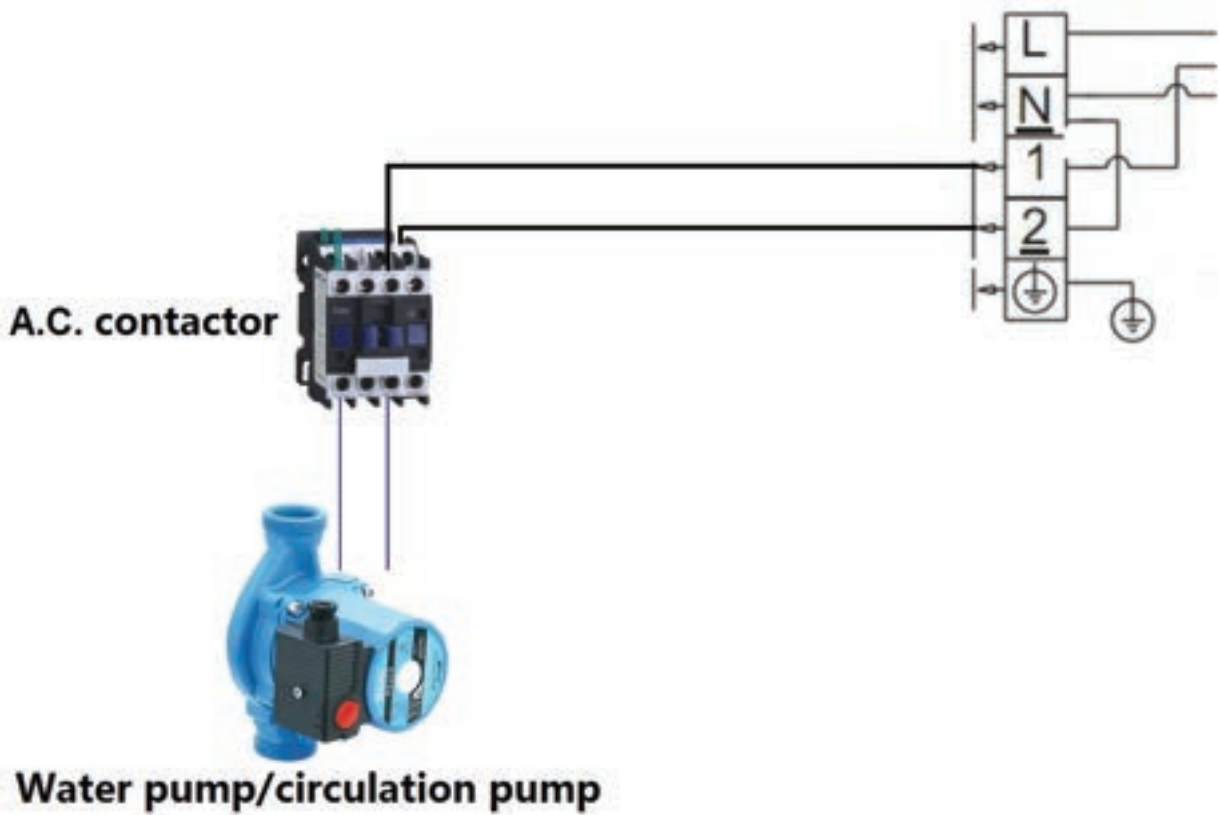

Figure 16

8.4 Electric wiring diagram

COMP : COMPRESSOR	GND : GROUND
AMBT: AMBIENT TEMPERATURE SENSOR	WFS: WATER FLOW SWITCH
LOW : LOW PRESSURE SWITCH	HIGH : HIGH PRESSURE SWITCH
COIL: EVAPORATOR COIL TEMPERATURE SENSOR	OWT/INWT: INLET / OUTLET WATER TEMPERATURE SENSOR

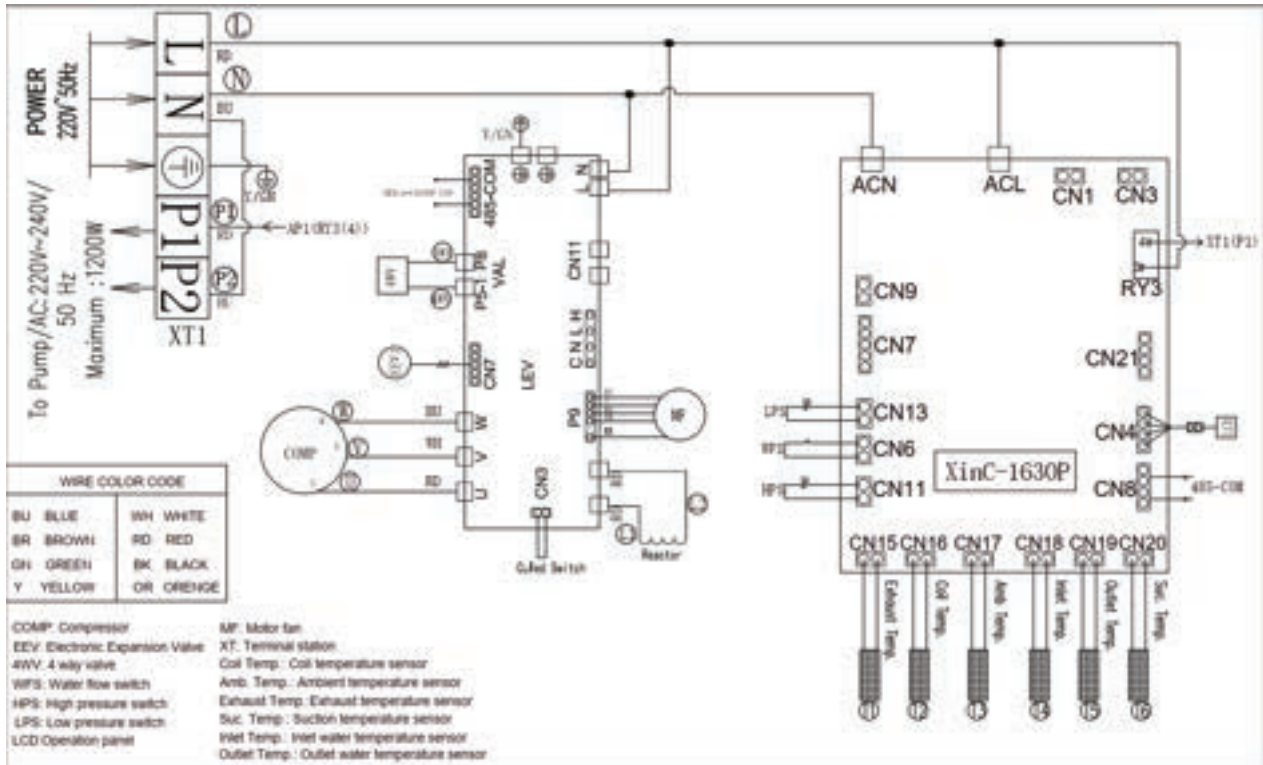





Figure 17 Electrical wiring diagram

9. Operating Instructions





1. Controller Operation

- To turn the heat pump on push and hold down the Power  button for 3-5 seconds.
To turn the heat pump off push and hold down the Power  button for 3-5 seconds.
The display will change and you will see an IN temperature & an OUT temperature
this indicates that the unit is in a standby/off mode.

- Press  Mode button to change between Heating, Cooling and Auto modes



- In heating mode:  lights up on the top line.



- Auto Mode: When heating in Auto mode,  +  light up

When cooling in Auto mode,  +  light up



- In cooling mode:  lights up on the top line.



Icon meaning:



 +  Normal cooling mode, when set to cooling, this icon is always on;



 +  Normal heating mode, when set to heating, this icon is always on;

 Auto mode, when set to Auto, this icon is always on;

 +  Boost heat, when set to boost heat, these two icons are always on;



 +  Fast cooling, when set to fast cooling, these two icons are always on;

 +  Eco heat mode; when set to slow heating mode, these two icons are always on;



 +  Eco cool mode; when set to slow cooling mode, these two icons are always on;







- **Temperature Setting**

In the main interface, press  or  to adjust temperature setting. At the same time, the SET icon will light up. It will automatically exit after 3s without operation.

- **Inquiry and Setting of User Parameters**

*In the main interface, press and hold  for 3 seconds to enter the user parameter query interface. Press  or  to query each parameter.



*In the user parameter query interface, select a parameter and press  to enter the parameter setting, this parameter will flash, then press  or  to modify the value. Press  again to confirm this setting.



*In the Inquiry or Setting interface, it will return to main interface automatically if there is no operation for 30 seconds and the modified parameter value will be saved automatically. You



can also return to the main interface by the .



- **Time Setting**

- ✓ Press and hold  for 5 seconds to enter real-time setting. The Hour & Minute will flash in the same time.



- ✓ Then press  again to enter Hour setting, the Hour icon will flash only, then press  or  to modify the value.

- ✓ Then press  again to enter Minute setting, the Minute icon will flash only, then press  or  to modify the value.

- ✓ Then press  again to confirm the setting. Or you can press  or no operation for 30 seconds to confirm the setting.



- **Timer Function**

- ✓ In the main interface, press  to enter the interface of the timer setting. You can set two timers. (Timer group 1 & Timer group 2).



- ✓
- ✓ Timer group 1 flashes, then setting this Timer On based on the process of real-time

setting. Then press  again to enter Timer Off setting of Timer group 1

- ✓ After that, press  to confirm the Timer setting. Then press  or  to enter into setting of Timer group 2, the setting process is the same to Timer group 1.
- ✓ The No. of Timer group will be showed on the main interface if the setting is valid.
- ✓ If the Timer on & Timer off is the same in one Timer group, then this Timer setting is invalid.

- ✓ You can press  or no operation for 30 seconds to confirm the setting.



- **Lock and Unlock**

- ✓ If there is no operation for 60 seconds, the controller will enter sleep status and the screen will be automatically locked. The screen “lock key” icon will be on.





- ✓ In the locked status, click any button to light up the screen. After pressing and holding the “ON/OFF” key for 5 seconds, the buzzer “Di” sounds, the key is unlocked, and the “lock key” icon turns off.

- **Restore to factory parameter settings (can be set only when heat pump is OFF)**

- ✓ In the main interface of the heat pump off, press and hold  and  at the same time for 5 seconds to restore the heat pump to factory default parameter settings. All the parameters will return to default value.





2. Parameters

2.1 Press and hold  for 3 seconds to enter temperature parameter checking status, then press  or  to select parameters.

Parameter	Name	remark
r1	Exhaust temperature	
r2	Gas return temperature	
r3	Water inlet temperature	
r4	Water outlet temperature	
r5	Evaporator coil temperature	
r6	Ambient temperature	
r7	Reserved	
r8	Reserved	
r9	Reserved	
r10	Reserved	
r11	Reserved	
Ft	target frequency	
Fr	current frequency	
1F	Electronic expansion valve open	
2F	Reserved	
od	mode	1:cooling 4:heating
Pr	fan speed	AC fan: 1:high 2:middle 3:low DC fan: running speed (*10)
dF	defrosting status	
OIL	oil return status	
r1	Reserved	
r2	Bottom chassis heater	
r3	Reserved	
STF	4-way valve	
HF	Reserved	
PF	Reserved	
PTF	Reserved	
Pu	Water pump	
AH	high speed fan ON/OFF	
Ad	middle speed fan ON/OFF	
AL	low speed fan ON/OFF	
dcU	DC bus voltage	
dcC	Inverter compressor current (A)	
AcU	Input voltage	
AcC	Input current	
HE1	Fault code history	
He2	Fault code history	
He3	Fault code history	

HE4	Fault code history	
Pr	Protocol version	
Sr	Software version	

2.2 User parameter checking

Press  button 3 seconds to enter parameter checking status, then press  or  to select parameter.

Parameter	description	range	default
L0	heating	20°C ~ 60°C	26°C
L1	Adjustment of temperature difference before restart	2°C ~ 18°C	2°C
L2	Adjustment of temperature difference before stop	2°C ~ 18°C	2°C
L3	cooling	2°C ~ 30°C	12°C
L4	Adjustment of temperature difference before restart when cooling	2°C ~ 18°C	2°C
L5	Adjustment of temperature difference before stop when cooling	2°C ~ 18°C	2°C
L6	Set temperature at Auto mode	8°C ~ 60°C	26°C
L7	water pump mode	0: water pump always running 1: water pump will stop 60S after compressor stop, then run 5 min every(L8)min	0
L8	water pump run 5min every(L8)min	3 ~ 180min	30

2.3 Error Codes

Error Code	Description	Remark
E01	exhaust temperature sensor failure	
E05	evaporator coil temperature sensor failure	
E09	Gas return temperature sensor failure	
E17	return water temperature sensor failure	
E18	water outlet temperature sensor failure	
E21	reserved	
E22	ambient temperature sensor failure	
E25	water flow issue - check water flow	
E27	controller PCB and inverter driver communication failure	
E28	Controller PCB EEPROM failure	
E29	inverter driver EEPROM failure	
P02	high/low pressure protection	
P11	exhaust temperature too high protection	
P15	temperature difference too big between water inlet and outlet	
P16	supercooling protection at cooling mode	
P17	anti-freeze protection	
P18	reserved	
P19	compressor overcurrent protection	
P24	fan motor protection	
P25	ambient temperature protection	
P26	water outlet temperature too high protection	
P27	evaporator coil temperature too high when cooling	
r02	compressor driver failure	
r05	IPM module too hot protection	
r06	heat pump current too big	
r10	DC voltage too big	
r11	DC voltage too small	
r12	AC voltage too small	
r24	electrical power failure	

10. Exploded View

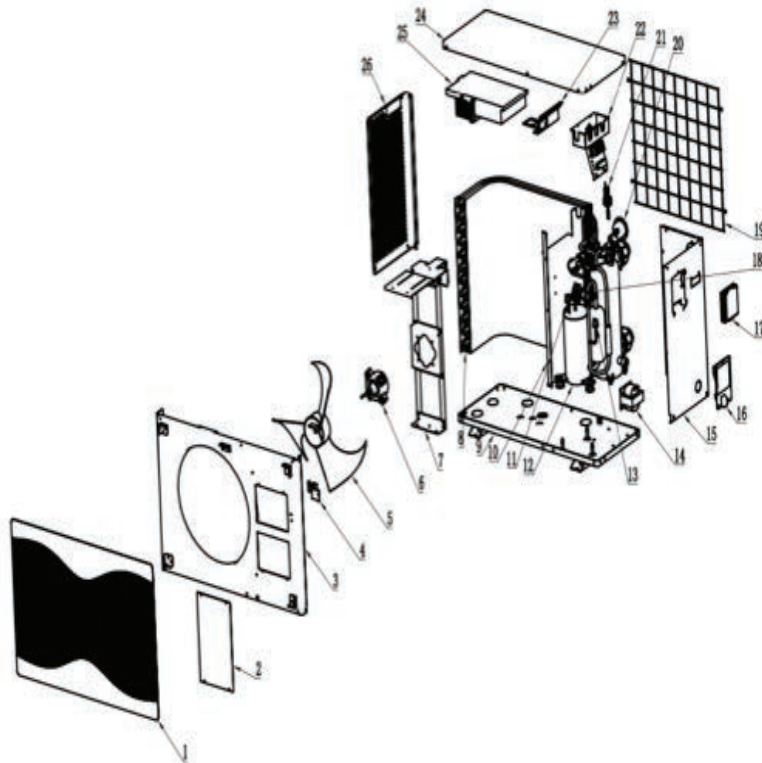

26	Left panel				13	Low pressure switch	
25	Electrical box				12	Compressor	
24	Top panel				11	High pressure switch	
23	Support frame				10	Middle partition	
22	Electrical terminal block				9	Bottom Panel	
21	Flow detector				8	Evaporator	
20	Manometer				7	Fan motor mount	
19	Back net				6	Fan motor	
18	Check valve				5	Fan propeller	
17	Control panel				4	Valve support frame	
16	Handle				3	Air deflector	
15	Right Panel				2	Service panel	
14	Reactive resistance				1	Front panel	

11. Wireless / remote control

Download and install the software:



User registration

When using the "smart life" software for the first time, user registration is required.

Click the "Create New User" link to enter the registration interface.

If you already have an account, just click login.

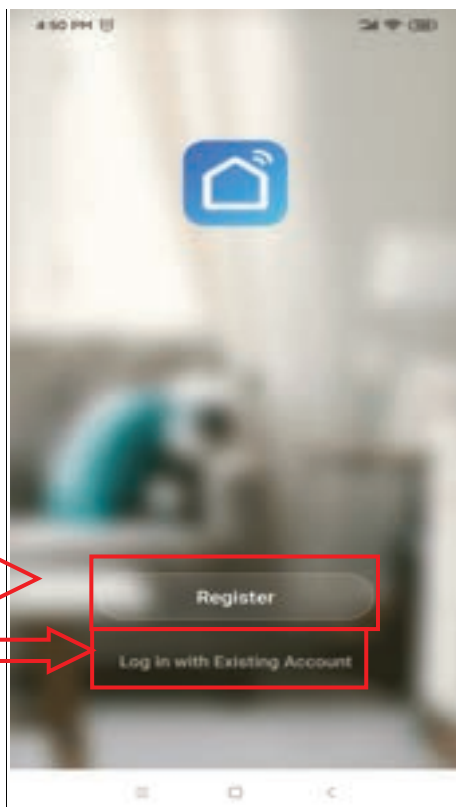

After entering the registration page, please follow the instructions on the page to register.

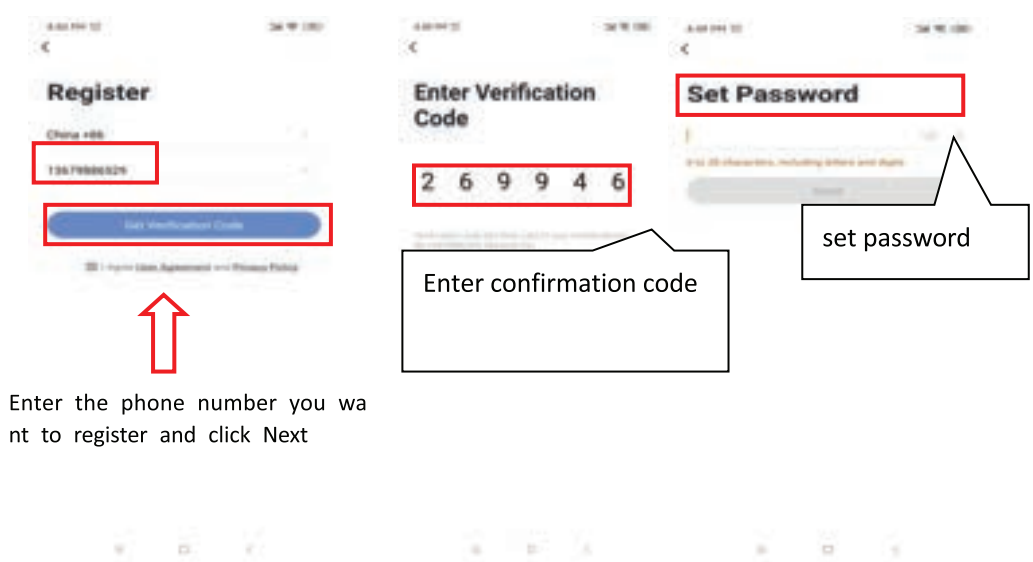

Enter the phone number you want to register and click Next

User login

After successful registration, the software will jump to the login interface or directly log in successfully, enter the correct "user name" and "password" to log in.

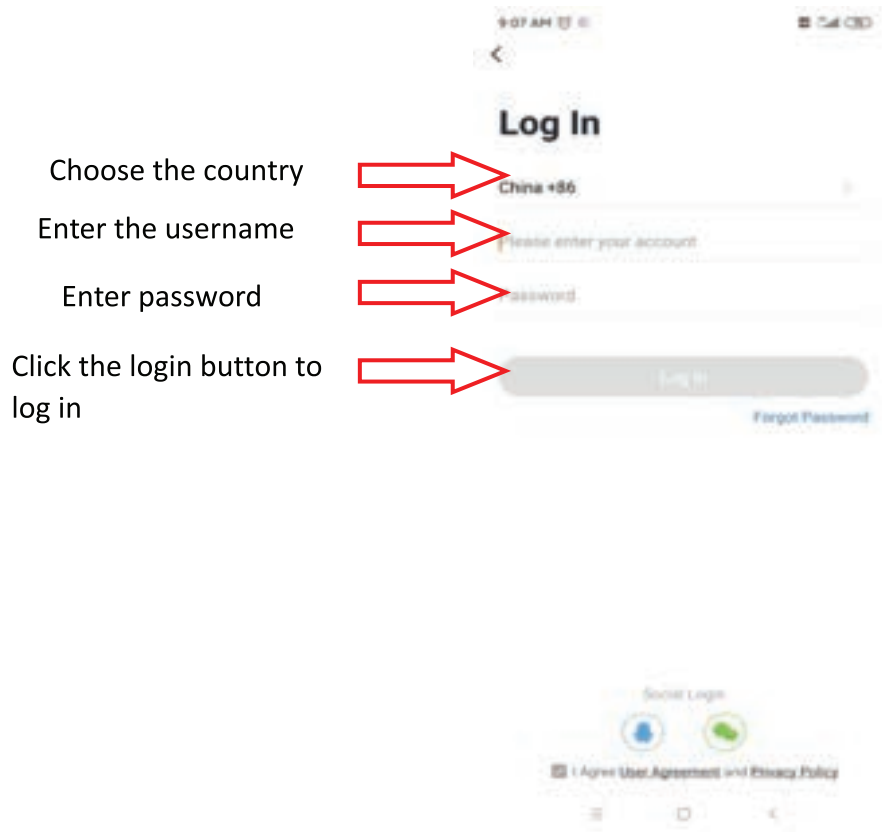

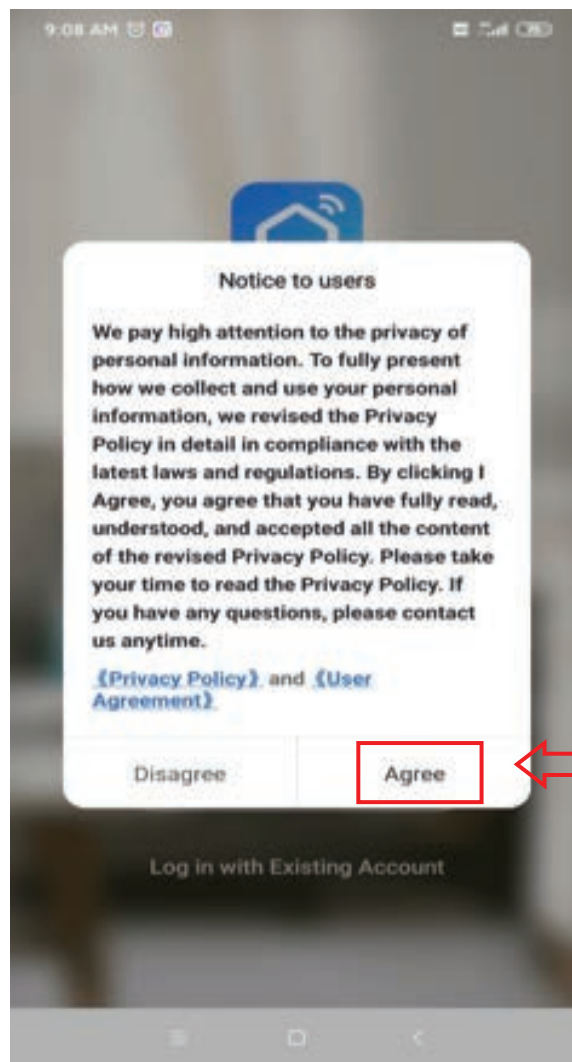

Need to select "Agree"

The phone needs to be connected to the network through the WIFI network

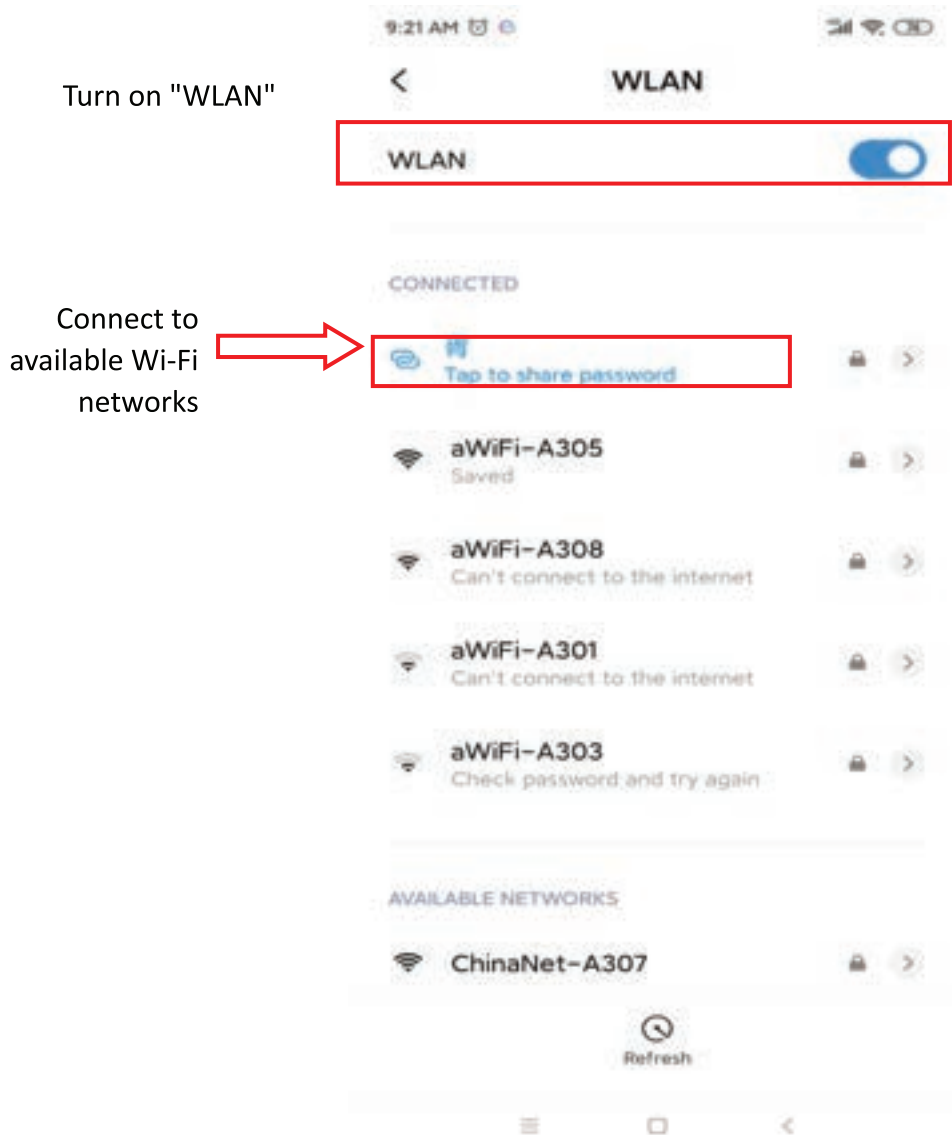

This WIFI is not the WIFI in the module but the WIFI that can be connected to the Internet;

After users log in to the software, they can add devices

Device binding

Click "+" or "Add Device" in the upper right corner to bind.

Click to enter the "Add Device Type" interface

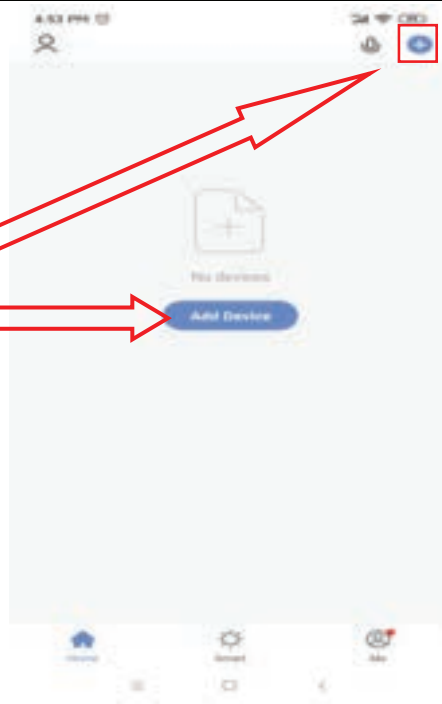

Choose Icon Scenario Switch (Wi-Fi)

If this icon does not work, go to large home appliances
Choose the Icon Smart Heat Pump (BLE + Wi-Fi).

If this icon does not work go to the left of the screen, choose others, and then the icon connector (Wi-Fi).

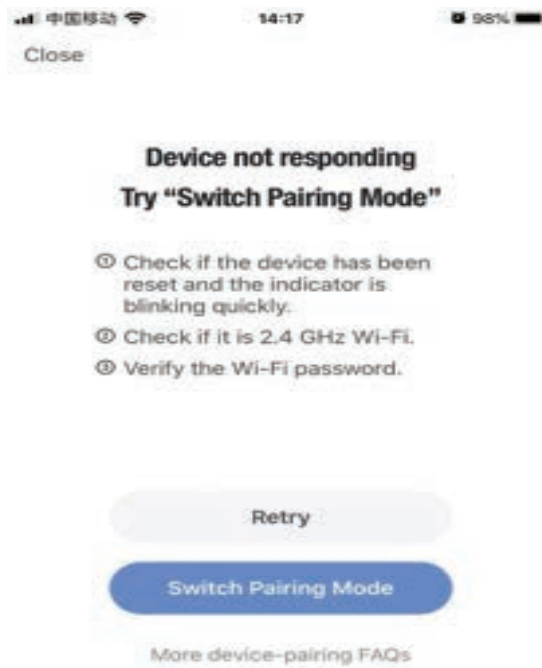

If the network distribution fails, the APP will display the page as shown in the figure, you can choose to re-add or view the help.

Compatibility mode:

Select "Other Ways" in the Add Device

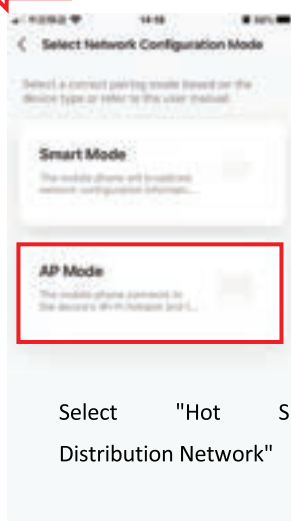
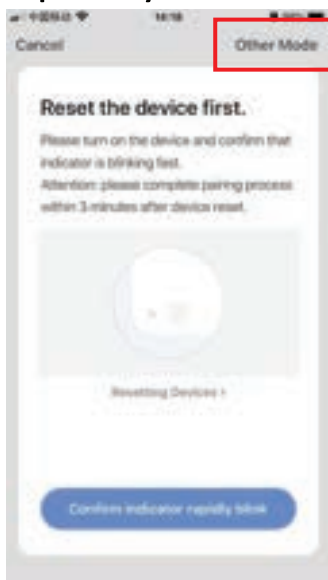

Select "Hot Spot Distribution Network"

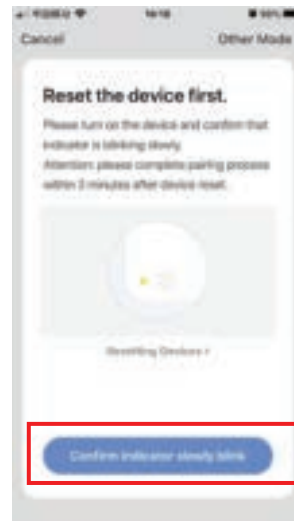

Press and hold the timing key +,down key +,power key simultaneously for 3 seconds to enter the "compatibility mode" distribution network.



Click Go to connect and jump to the Wi-Fi interface, select Wi-Fi with the words SmartLife-xxxx

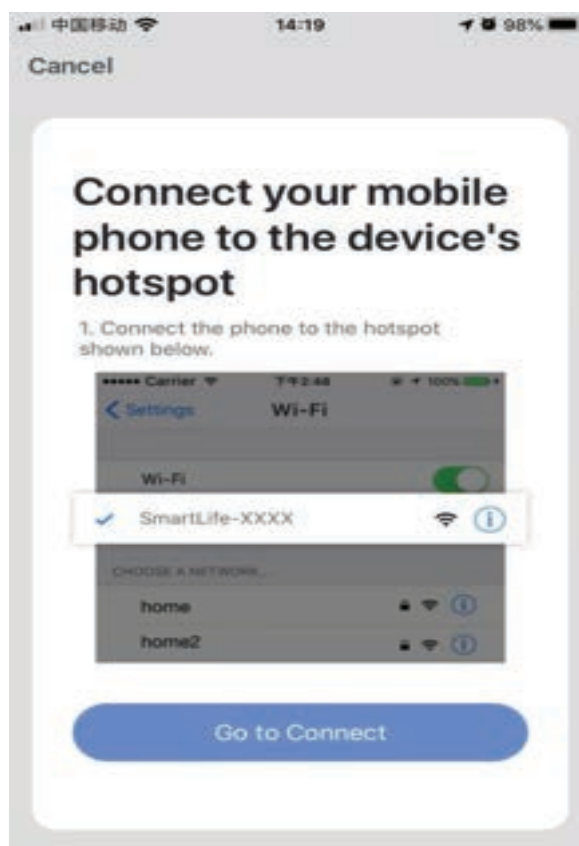

After selecting and connecting, return to the APP interface and enter the network distribution process

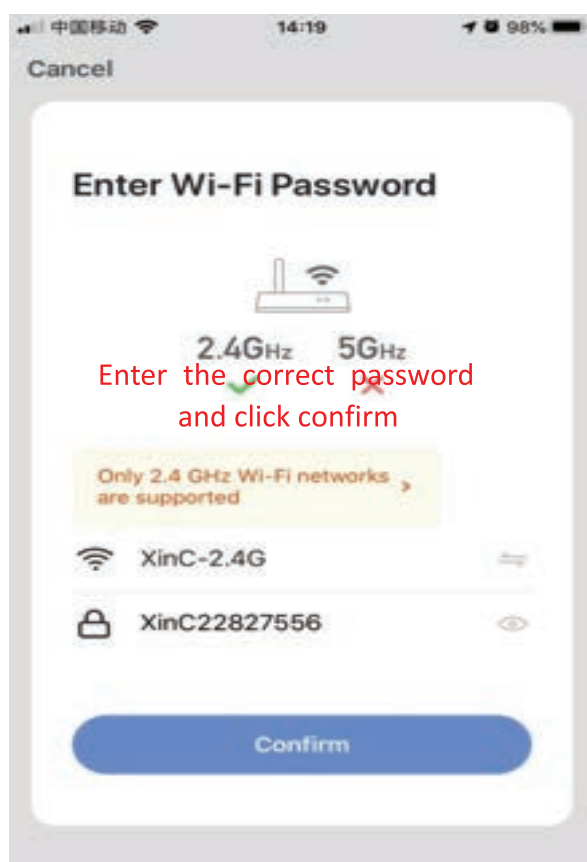

Enter the correct password and click confirm

The remote controller simultaneously press the up key + mode key for 3 seconds to enter the "default mode" distribution network

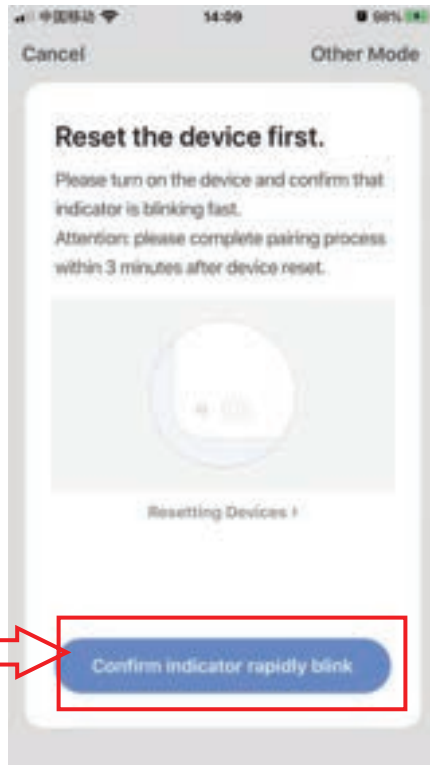

Enter the Wi-Fi password

Enter and click to confirm

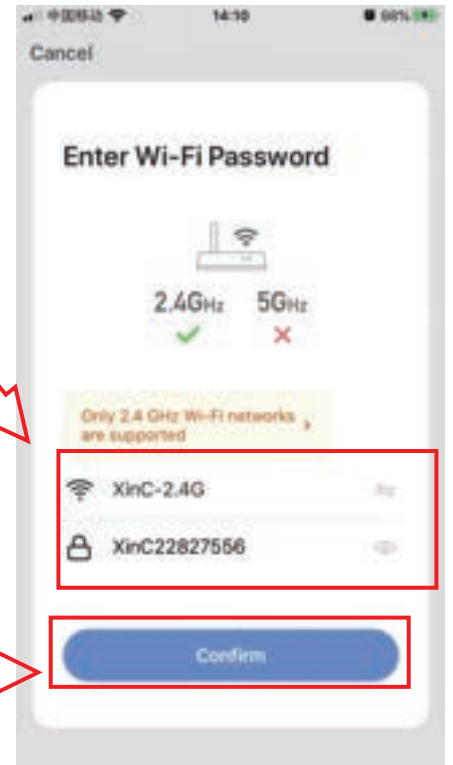

Enter the password and confirm it will jump to the connection interface

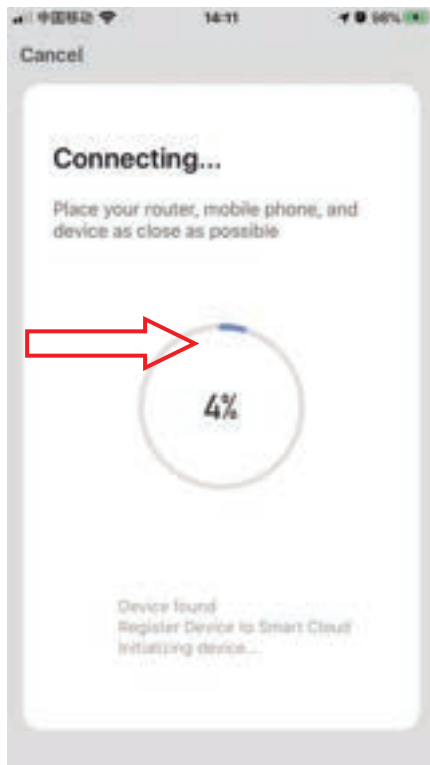

Device name can be modified

Click Finish to start device control

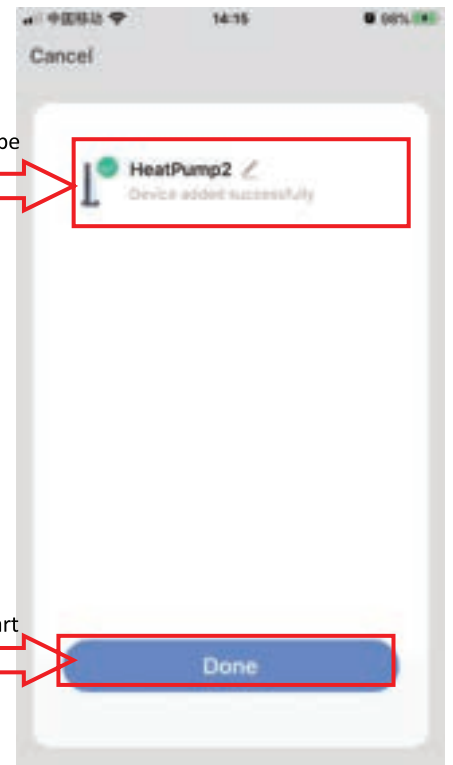

Control introduction

Successfully bound device

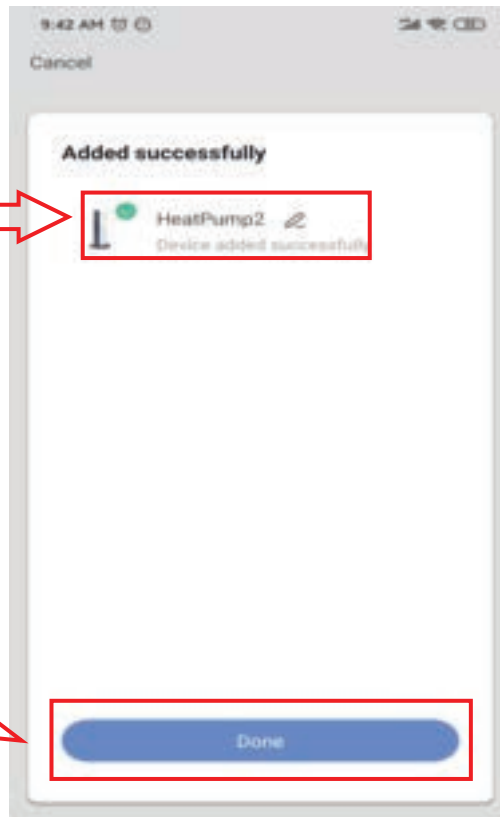

Click to enter control

Set temperature, and current inlet water



Equipment details

Set temperature

Switch machine control

Timing setting, can set the timing on or off

Equipment working mode selection

12. Adjusting and Initial operation

12.1 Attention

- Do adjustment after electrical safety inspection.
- After the power is switched on, start the test running of heat pump, to see if it can function well.
- Forced operation is forbidden, because it is very dangerous to work without protector.

12.2 Preparation Before Adjustment

- Check that the system is installed correctly.
- Pipes and cables are connected correctly.
- Check that accessories are installed.
- Make sure the drainage is working properly.
- Make sure the system piping and connections are properly insulated.
- Check that ground/earth connection had been made correctly.
- Check that supply voltage can meet the requirement of rated voltage.
- Check that air inlet and outlet are working correctly.
- Check that the electrical leakage protector works correctly.

12.3 Adjustment Process

- Check that switch of display controller works properly.
- Check that function keys on display controller work properly.
- Check that indicator lights work properly.
- Check that drainage works properly.
- Check that system works correctly after starting up.
- Check that water outlet temperature is acceptable.
- Check if there are vibrations or abnormal sounds when the system is functioning.
- Check if the wind, noise and condensate water produced by the system affect the surrounding environment.
- Check if there is any refrigerant leakage.
- If any fault occurs, please check the instructions first to analyze and remove the fault.

13. Operation and maintenance

13.1 The heat pump should be installed and operated by qualified professionals. To ensure the continued correct functioning of the system it is recommended that it should be checked and maintenance should be carried out at regular. During maintenance, please pay attention to the points below.

- Check that all parameters are normal during system operation.
- Check for loose electrical connections and fix if necessary.
- Check electrical components and replace if necessary.
- After prolonged use, there may be calcium or other mineral substances deposited on the surface of the heat exchanger copper coil. This could affect the performance of heat exchanger and lead to higher than normal electrical consumption, increased discharge pressure and reduced suction pressure. Formic acid, citric acid, acetic acid or other organic acid can be used to clean the coil.
- Any dirt accumulated on the surface of the evaporator fins should be blown away using a 0.6Mpa air compressor, brushed by fine copper wire, or flushed with a high-pressurized water hose, usually one time per month. If there is too much dirt, we can use a paintbrush dipped in gasoline to clean the evaporator.
- After restarting the unit following a long period of inactivity, please do the following: examine and clean the equipment carefully, clean the water pipe system, check the water pump and fasten all the wire connections.
- Always use original replacement parts.

13.2 Refrigerant

Check the refrigerant filling condition by reading the data of the liquid level from the display screen, and also by checking the air suction and exhaust pressure. If there is a leakage or any components of the refrigeration circulation system have been changed, it is necessary to check the air tightness before anything else.

13.3 Leak detection and air tightness testing

During leak detection and air tightness experiment, never allow oxygen, ethane or other harmful flammable gases to enter the system: only compressed air, fluoride or refrigerant can be used for such a test.

13.4 To remove the compressor, please do the following:

- Turn off the power supply
- Remove the refrigerant from the low pressure end; make sure you reduce the exhaust speed, and avoid leakage of frozen oil.
- Remove the compressor air suction and exhaust pipe.
- Remove the compressor power cables.
- Remove the compressor fixing screws.
- Remove the compressor.

13.5 Conduct regular maintenance according to the user manual instruction, to make sure the unit running is in good condition.

- If there is a fire, disconnect the power immediately and put the fire out with fire extinguisher.
- The unit's operating environment should be free of gasoline, ethyl alcohol and other flammable materials to avoid explosions or fire.
- Malfunction: if any malfunction occurs, find the reason, fix it and then reboot the unit. Never reboot the unit forcibly if the cause of the malfunction has not been eliminated. If there is refrigerant leakage or frozen liquid leakage, switch the unit off. If it is not possible to turn the unit off from the controller then disconnect the main power supply..
- Never short connect the wire for device protection otherwise, in case unit malfunction, the unit will not be protected normally and could be damaged.

14. Fault analysis and elimination method

Fault	Possible cause	Detection and elimination method
Discharge pressure is too high.	<ul style="list-style-type: none"> ◆ There is air or other non-condensable gas existed in the system. ◆ Water heat exchanger is scaling or fouling blockage. ◆ The circulation water volume is not enough. ◆ Refrigerant charging is too much. 	<ul style="list-style-type: none"> ● Vent the air from water heat exchanger ● Wash and clean the water heat exchanger ● Examine the water system pipeline and pump. ● Drain part of the refrigerant
Discharge pressure is too low.	<ul style="list-style-type: none"> ◆ Liquid refrigerant flow through evaporator to compressor, which make foam for the frozen oil ◆ Suction pressure is too low ◆ Refrigerant charging is too less, the refrigerant air goes into liquid pipeline 	<ul style="list-style-type: none"> ● Examine and adjust the expansion valve, make sure the expansion valve temperature sensor bulb is close connected with the air suction pipe, and absolutely insulated with the ambient environment. ● Please refer to "Fluorine filling if suction pressure too low"
Suction pressure is too high.	<ul style="list-style-type: none"> ◆ Discharge pressure is too high. ◆ Refrigerant charging is too much. ◆ Liquid refrigerant flow through evaporator to compressor. 	<ul style="list-style-type: none"> ● Drain part of the refrigerant. ● Examine and adjust the expansion valve, make sure the expansion valve temperature sensor bulb is close connected with the air suction pipe, and absolutely insulated with the ambient environment.
Suction pressure is too low.	<ul style="list-style-type: none"> ◆ Ambient temperature is too low. ◆ The evaporator liquid inlet or compressor suction pipe is blocked, expansion valve unadjusted, or failed. ◆ The refrigerant is not enough in the system. 	<ul style="list-style-type: none"> ● Adjust suitable overheat temperature, examine whether there is Fluorine leakage from the expansion valve temperature sensor bulb. ● Examine Fluorine leakage. ● Examine the installation condition.
Compressor stopped because of high pressure protection.	<ul style="list-style-type: none"> ◆ The water inlet temperature is too high, circulation water is not enough. ◆ The high pressure stop setting is not correct, the air suction overheat greatly. ◆ Fluorine filling is too much. 	<ul style="list-style-type: none"> ● Examine water system pipeline and water pump. ● Examine the high pressure switch. ● Examine the Fluorine filling volume, drain part of refrigerant.
Compressor stopped because of motor overloading.	<ul style="list-style-type: none"> ◆ The voltage is too high or too low. ◆ Discharge pressure is too high or too low. ◆ Device loading failure. ◆ Ambient temperature is too high. ◆ Motor or connecting terminal is in short circuit. 	<ul style="list-style-type: none"> ● The voltage should be controlled within more or less 20V than rated voltage, and phase difference within $\pm 30\%$. ● Examine the compressor current, compare with the full loading current indicated in the user manual. ● Improve air ventilation.
Compressor stopped because of built-in thermostat.	<ul style="list-style-type: none"> ◆ The voltage is too high or too low. ◆ Discharge pressure is too high. ◆ The refrigerant in the system is not enough. 	<ul style="list-style-type: none"> ● Examine the voltage to make sure it is within the specialized range. ● Examine the discharge pressure and find out the reason. ● Examine whether there is Fluorine leakage.
Compressor stopped because of low voltage production	<ul style="list-style-type: none"> ◆ Dry filter clogging. ◆ Expansion valve failure. ◆ The refrigerant is not enough. 	<ul style="list-style-type: none"> ● Examine, maintain, or change dry filter. ● Adjust or change expansion valve. ● Fill in refrigerant.
High noise of compressor	<ul style="list-style-type: none"> ◆ There is liquid hammer for liquid refrigerant flowing through evaporator to compressor. 	<ul style="list-style-type: none"> ● Adjust liquid supply, examine whether normal for the expansion valve and air suction over heat degree.
Compressor can not start.	<ul style="list-style-type: none"> ◆ Over current relay is tripped, insurance is burn. ◆ The control circuit is not connected. ◆ No current. ◆ The pressure is too low, which can not conduct the pressure switch. ◆ The contactor coil is burn out. ◆ Water system failure, relay is tripped. 	<ul style="list-style-type: none"> ● Set the control circuit in manul mode, restart the compressor after maintenance. ● Examine controlling system. ● Examine power supply. ● Examine whether the refrigerant is too less. ● Reconnect, adjust two of the wiring.

16. After-sale service

If your heat pump does not operate normally, please turn off the unit and cut off the power supply at once, then contact our service center or technical department.

Contact Details

**GREENSTAR SOLUTIONS
3/30 HINES ROAD O'CONNOR 6163**

08 93313868

admin@greenstarsolutions.net.au



Head Office 3/30 Hines Road, O'Connor WA 6163
P (08) 9331 3868
E admin@greenstarsolutions.net.au
W www.greenstarsolutions.net.au



WARRANTIES AND LIMITATION OF LIABILITY

We set out below what our warranty (**Product Warranty**) is in relation to the components (**Component**) of our pool heating system (Genesis™- Next Generation Heat Pump™) (**Product**) and our services (**Services Warranty**) in respect of initially installing our Product (**Services**) the period of time for which these warranties apply (**Warranty Period**) and all the information you need to know about making a claim. We also set out what the limitations on our liability are should you purchase a Product from us or should we render a Service to you. If you have any questions for us, please reach out using the contact details below!

Who is this Agreement Between?

This agreement (**Agreement**) is between Doncon & Co Pty Ltd Pty Ltd T/A Green Star Solutions ABN 51 164 532 870 (**we, us or our**) and you, the person or entity that has purchased Product from us (as specified below), together the **Parties** and each a **Party**. This Agreement forms part of such terms and conditions as may apply to the sale of our products from time to time.

You accept this Agreement by instructing us (whether orally or in writing) to proceed with the supply of the Product, or making payment or part-payment to us in respect thereof.

Your Consumer Law Rights

Certain legislation, including the Australian Consumer Law, and similar consumer protection laws and regulations, may confer you with rights, warranties, guarantees and remedies relating to the supply of the Product by us to you which cannot be excluded, restricted or modified (**Consumer Law Rights**). The benefits given to you under this warranty are in addition to, and do not limit or derogate, your rights and remedies at law in relation to any products you have purchased from us, or services that you have received from us, including under the Australian Consumer Law within the *Competition and Consumer Act 2010* (CAA).

Our goods and services come with guarantees that cannot be excluded under the Australian Consumer Law. For major failures with the service, you are entitled:

- to cancel your service contract with us; and
- to a refund for the unused portion, or to compensation for its reduced value.



■ Pool Heating ■ PV / Thermal ■ Hydronic Heating ■ Solar Hot Water ■ Biomass ■ Commercial & Domestic



Head Office 3/30 Hines Road, O'Connor WA 6163
P (08) 9331 3868
E admin@greenstarsolutions.net.au
W www.greenstarsolutions.net.au



You are also entitled to choose a refund or replacement for major failures with goods. If a failure with the goods or a service does not amount to a major failure, you are entitled to have the failure rectified in a reasonable time. If this is not done you are entitled to a refund for the goods and to cancel the contract for the service and obtain a refund of any unused portion. You are also entitled to be compensated for any other reasonably foreseeable loss or damage from a failure in the goods or service.

Consumer guarantees (under the Australian Consumer Law) have no set time limit but generally last for an amount of time that is reasonable to expect, given factors such as the cost and quality of the Product or any representations made. Full details of your consumer rights, including what is considered a major failure, may be found at www.consumerlaw.gov.au.

What Products our Product Warranty Applies to

Our Product Warranty applies to the following:

Component	Warranty Period <i>(commencing on the date of purchase)</i>
Titanium Heat Exchanger	30 years pro-rata basis for residential installations.
Compressor	10 years pro-rata basis for residential installations.
Evaporator	3 years pro-rata basis for residential installations.
All other heat pump components	3 years for residential installations.
Genesis Link Automatic Controller	2 years for residential installations.
Genesis Switch Automatic Controller	2 years for residential installations.
Circulation pump	3 years for residential installations.



■ Pool Heating ■ PV / Thermal ■ Hydronic Heating ■ Solar Hot Water ■ Biomass ■ Commercial & Domestic



Head Office 3/30 Hines Road, O'Connor WA 6163
P (08) 9331 3868
E admin@greenstarsolutions.net.au
W www.greenstarsolutions.net.au



When the Product Warranty Applies

If during the Warranty Period, there is a fault or defect in the functionality of the Product or a Component as a result of our default (**Defect**), then we will use our best endeavours to remedy the Defect at our cost, save as otherwise set out herein.

Services Warranty

Subject to the terms of this Warranty, if during the first 12 months from the date of purchase of the Services from us the Services prove defective by reason of improper workmanship or materials (**Services Defect**), and if we determine that your claim under this warranty is successful in terms of this Warranty, we will resupply the Services. Your Consumer Law Rights may extend beyond the Warranty Period.

How to Claim Under our Product Warranty and Services Warranty

To make a claim under this warranty, you must notify us by email as soon as you become aware of the Defect and/or Services Defect, and in any event, within 1 month of when you become aware of the Defect and/or Services Defect, and include the following information in your email:

- your invoice number, if applicable;
- the serial number displayed on the Product or relevant Component;
- the date of installation of the Product; and
- a detailed description of the issue with the Product or Component.

You must work with our support team and provide any other information we reasonably require to assess your claim. We will notify you of our determination as to whether your claim is valid under this warranty and any determination we make will be final and binding.



■ Pool Heating ■ PV / Thermal ■ Hydronic Heating ■ Solar Hot Water ■ Biomass ■ Commercial & Domestic



Head Office 3/30 Hines Road, O'Connor WA 6163
P (08) 9331 3868
E admin@greenstarsolutions.net.au
W www.greenstarsolutions.net.au



If your Claim under our Product Warranty is Successful

Subject to your rights and remedies under the Australian Consumer law, if we determine your claim under this warranty is successful, we may, in our discretion, elect to:

- repair the Product or the relevant Component;
- pay you an amount as determined by us for the cost of repairing the Product or the relevant Component;
- replace the Product or Component;
- supply to you an equivalent Product;
- pay you an amount as determined by us for the cost of replacing the Product or the relevant Component; or
- pay you an amount as determined by us for the cost of acquiring an equivalent Product.

To the maximum extent permitted by law, the remedies above will be your sole and exclusive remedy in relation to the Defect.

If any materials, parts or features required to facilitate any repair or replacement are unavailable or no longer in production, or your model of Product or Component is no longer available or in production, we will either use our best endeavours to repair the Product or Component using appropriate equivalent materials, parts or features, replace the Product or Component with an appropriate equivalent model or provide you with a full or partial refund, as required, and as determined by us in our sole discretion. If the defective part of the Product is not essential to the functionality of the Product, then we may issue a partial refund to you.

This warranty only sets out the Warranty Period within which we will offer you a repair, refund or replacement. Your rights under the Australian Consumer Law may extend beyond the Warranty Period.





Head Office 3/30 Hines Road, O'Connor WA 6163
P (08) 9331 3868
E admin@greenstarsolutions.net.au
W www.greenstarsolutions.net.au



Costs

Our labour, travel and freight costs incurred as a result of attending to remedy a Defect or Services Defect are excluded after a period of 12 months. These costs are to be paid by you. Your failure to make payment in respect of these costs on or before the date of our invoice to you in respect hereof will void the Product Warranty or the Services Warranty, as applicable.

To the extent that it is determined by us, acting reasonably, that the Product, a Component, or our Services in respect of which you have sought to exercise your rights under a Product Warranty or Services Warranty is:

- not defective; or
- is defective as a result of the exclusions mentioned in the clause "Exclusions from our Product Warranty and Services Warranty",

then we reserve the right to charge you at our current hourly rate for all costs incurred by us which are associated with examining the Product, including our travel and associated costs.

Exclusions from our Product Warranty and Services Warranty

To the maximum extent permitted by law, this warranty does not cover, and we will have no liability in respect of, and you waive and release us from, any liability (under this warranty or otherwise), in relation to any Defect or Services Defect which is caused (or partly caused) or contributed to, by any:

- act or omission, accident, improper cleaning, improper assembly, transportation or negligence by you or any third party not engaged by us (including any third-party installer of your Product);
- cosmetic changes that occur overtime;
- failure on your part to follow any instructions or guidelines (including any manual) provided by us or the manufacturer in relation to your Product;
- use of your Product otherwise than for any application or use specified by us or the manufacturer;
- reasonable wear and tear of your Product or any of the Components therein;
- continued use of your Product (where such use is not reasonable) after any Defect in your Product becomes apparent or would have become apparent to a reasonably prudent person;



■ Pool Heating ■ PV / Thermal ■ Hydronic Heating ■ Solar Hot Water ■ Biomass ■ Commercial & Domestic



Head Office 3/30 Hines Road, O'Connor WA 6163
P (08) 9331 3868
E admin@greenstarsolutions.net.au
W www.greenstarsolutions.net.au



- failure by you to notify us of any Defect in your Product within a reasonable period of time after you become aware of or ought to have reasonably become aware of the relevant Defect;
- act of God or force majeure event (including but not limited to war, riot, invasion, act of terrorism, contamination, earthquake, flood, fire, or other natural disaster, or any other event or circumstance beyond our or the manufacturer's reasonable control);
- insect or rodent ingress into the Product or its surrounds;
- repair, replacement, maintenance, or otherwise compromise of the Product by you or any person other than us, a third-party approved by us or the manufacturer; or
- damage caused by exposing the products to extreme weather conditions, harsh or adverse pool or spa water conditions, or chemicals / agents that are known to damage the Product.

Subject to your Consumer Law Rights, we exclude all warranties, and all Products (including the Components), Services and work are provided to you without warranties of any kind, either express or implied, whether in statute, at law or on any other basis, except where expressly set out herein.

Liability

Despite anything to the contrary, to the maximum extent permitted by law:

- neither Party will be liable for consequential loss, which includes any consequential loss, indirect loss, real or anticipated loss of profit, loss of benefit, loss of revenue, loss of business, loss of goodwill, loss of opportunity, loss of savings, loss of reputation, loss of use and/or loss or corruption of data, whether under statute, contract, equity, tort (including negligence), indemnity or otherwise;
- a Party's liability for any expense, cost, liability, loss, damage, claim, notice, entitlement, investigation, demand, proceeding or judgment (whether under statute, contract, equity, tort (including negligence), indemnity or otherwise), howsoever arising, whether direct or indirect and/or whether present, unascertained, future or contingent and whether involving a third party or one of the Parties (**Liability**), will be reduced proportionately to the extent the relevant Liability was caused or contributed to by the acts or omissions of the other Party (or any of its personnel), including any failure by that other Party to mitigate its loss; and





Head Office 3/30 Hines Road, O'Connor WA 6163
P (08) 9331 3868
E admin@greenstarsolutions.net.au
W www.greenstarsolutions.net.au



- save for what is set out herein, our aggregate liability for any Liability arising from or in connection with our Product or Services will be limited, in our sole discretion, to us resupplying the Product, Component or Services to you, to us repaying you an amount of the price paid by you to us in respect of the supply of the Services, Product or relevant Component to which the Liability relates, or to us repaying you an amount as set out herein in respect of the supply of the Services, Product or relevant Component to which the Liability relates.

General

Delays: We will have no liability, and you waive and release us from any liability, for any delays (including any costs arising out of any delays) in providing any work or services (including repairs) under this warranty, or in assessing any claim made by you under or in relation to this warranty.

No third-party reliance: The benefit of this warranty is for you only, and no other person or third party can rely on or make a claim under this warranty. For the avoidance of doubt, if you resell the Product, this warranty will be void.

No assignment or transfer: This warranty or the benefit under this warranty cannot be assigned or transferred to any other person or third party.

Severance: If any provision (or part of it) under this warranty is held to be unenforceable or invalid in any jurisdiction, then it will be interpreted as narrowly as necessary to allow it to be enforceable or valid. If a provision (or part of it) under this warranty cannot be interpreted as narrowly as necessary to allow it to be enforceable or valid, then the provision (or part of it) must be severed from this warranty and the remaining provisions (and remaining part of the provision) of this warranty are valid and enforceable.

Jurisdiction and applicable law: This warranty is only valid and enforceable in Australia and is governed by the laws of Western Australia and the Commonwealth of Australia. Each Party to this warranty irrevocably and unconditionally submits to the exclusive jurisdiction of the courts operating in Western Australia.



■ Pool Heating ■ PV / Thermal ■ Hydronic Heating ■ Solar Hot Water ■ Biomass ■ Commercial & Domestic



Head Office 3/30 Hines Road, O'Connor WA 6163
P (08) 9331 3868
E admin@greenstarsolutions.net.au
W www.greenstarsolutions.net.au



What are our Contact Details?

Doncon & Co Pty Ltd Pty Ltd T/A Greenstar Solutions ABN 51 164 532 870

Email: admin@greenstarsolutions.net.au

Phone: 08 9331 3868

Address: 3/30 Hines Road, O'Connor, Western Australia 6163



■ Pool Heating ■ PV / Thermal ■ Hydronic Heating ■ Solar Hot Water ■ Biomass ■ Commercial & Domestic