

INSTALLATION AND OPERATION MANUAL

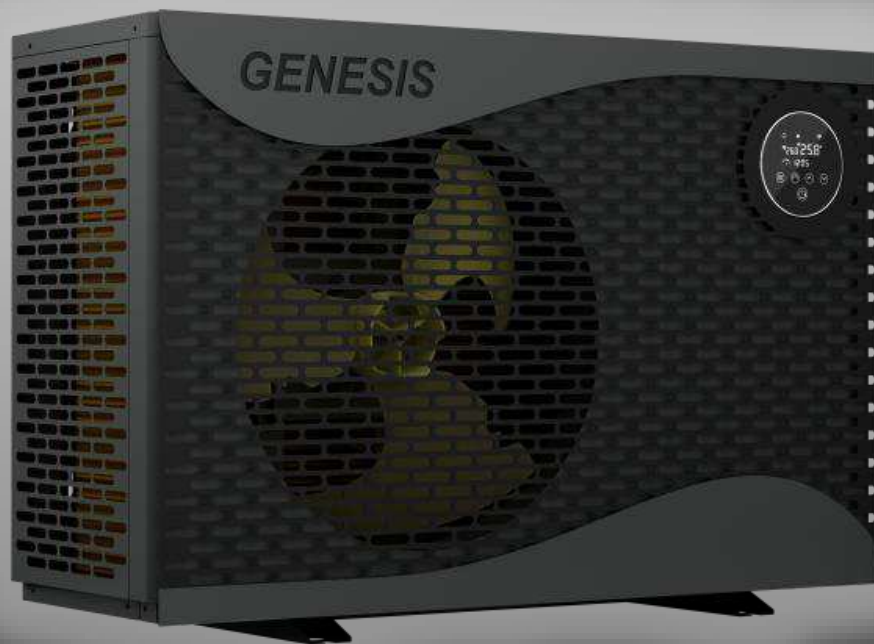

FULL INVERTER SWIMMING POOL HEAT PUMP FRONT DISCHARGE



Thank you very much for purchasing our product, please keep and read this manual carefully before you install the heat pump.

Unit Installed By: _____

Unit Install Date: _____

Unit Serial Number: _____









CONTENTS

1. PRECAUTIONS	3
1.1 Electrical Safety	4
1.2 DO'S AND DON'TS	5
2. HEAT PUMP UNIT WORKING PRINCIPLE	6
2.1 Heat Pump Operation.....	6
2.2 Air Source Heat Pump Working Principle	7
3. GENERAL INFORMATION	8
3.1 Accessories	8
3.2 Technical Specification	9
4. INSTALLATION OF THE UNIT	11
4.1 Installation Guidelines	11
4.2 Installation Check	11
4.3 Installation Space	12
4.4. Heat Pump Dimensions	14
4.5 Lifting.....	15
5. INSTALLATION INSTRUCTION	15
5.1. Transportation.....	16
5.2. Installation of Drain Pipe	17
5.3. Installation of Water Union	18
5.4. Installation of Water Pipe.....	18
5.5 Installation Options	19
5.6 Connection Sizes.....	21
5.7 Required Water Quality.....	21
6. ELECTRIC INSTALLATION	22
7. INSTALLATION OF OPTIONAL ACCESSORIES	26
7.1 Selection of the Water Pump	26
8. TESTING	27
8.1. Initial Inspection	27
8.2. Leakage Detection	27
8.3. Trial Operation.....	27
9. WORKING MODE	28
10. OPERATION	29
10.1. Overview of Wire Controller	29
10.1.1. Icon.....	29
10.1.2. Key	30
10.1.3. Keys Combination.....	30

10.2. Operation of Wire Controller	31
10.2.1 Power.....	31
10.2.2 Mode	31
10.2.3 Temperature Setting	31
10.2.4 Wi-Fi Connection	31
10.2.5. View Operating Parameters	32
10.2.6. Fault and Protection	33
10.2.7. Clock Setting.....	34
10.2.8. Power ON/OFF Timer Setting.....	34
10.3. Connection and Operation of APP	35
10.3.1. APP Download	35
10.3.2. User Registration	36
10.3.3. User Login.....	36
10.3.4. Add Device.....	38
10.3.5. Connection	39
10.3.6. Wi-Fi Control Interface.....	44
10.3.7. Share Device to Your Family Members	45
11. MAINTENANCE.....	46
11.1. Cleaning.....	46
11.2. Inspection	46
11.3. Winterizing	46
12. EXPLODED VIEW	47
13. ADJUSTING AND INITIAL OPERATION	48
13.1 Preparation Before Adjustment	48
13.2 Adjustment Process.....	48
14. OPERATION AND MAINTENANCE.....	49
14.2 Refrigerant.....	49
14.3 Leak Detection and Air Tightness Testing	49
14.4 To Remove the Compressor, please do the following:	50
14.5 Conduct regular maintenance according to the user manual instruction, to make sure the unit running is in good condition.....	50
15. FAULT ANALYSIS AND ELIMINATION METHOD	51
16. AFTER-SALE	52
17. WARRANTIES AND LIMITATION OF LIABILITY.....	53

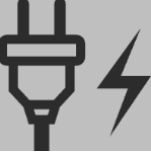
1. PRECAUTIONS

The following are special precautions that need to be followed strictly.

	<p>The refrigerant used in this equipment is flammable. Exposure of refrigerant to external ignition sources may cause a fire hazard. This equipment needs to be kept away from any source of fire.</p>
	<p>Read this manual carefully before performing any operation of the equipment.</p>
	<p>The installation and maintenance of this equipment must be performed by professional service personnel.</p>
	<p>Service personnel should strictly refer to this manual when installing, operating or maintaining the equipment.</p>
	<p>Before installing the equipment, the power supply, voltage, and frequency must be confirmed to be correct. Connect the power cord correctly according to the wiring diagram on the device.</p>
	<p>The equipment must be properly grounded to prevent the risk of electric shock due to leakage of electricity.</p>
	<p>The equipment must be vacuumed thoroughly before welding. Welding should only be done by professional service personnel.</p>
	<p>Install the unit OUTDOORS. The equipment must be placed in a well-ventilated area. Installing your heat pump indoors or in an enclosed area is not recommended.</p>

1.1 Electrical Safety

Range of applications:

1. Power supply: 220V-240V/1N~50Hz.
2. Ambient temperature: -10°C - 43°C.
3. Working water temperature: Min. inlet water temperature 8°C,Max. outlet Water Temperature 40°C.
If the system is always used beyond the available water range, please contact with manufacturer.



- The installation should be done by a professional person, to prevent leaking, electrical shock or fire in accordance to AS/NZS3000, Electrical Installations.
- Confirm the ground connection, if the ground connection is not correctly done, it may cause electric shock.
- **Install the unit OUTDOORS. The equipment must be placed in a well-ventilated area. Installing your heat pump indoors or in an enclosed area is not recommended. If the unit is allowed to recirculate its own cold air the unit's efficiencies will be affected.**
- Don't put fingers or objects into the air inlet outlet as the rotating fan could cause serious injuries.
- If you smell anything burning, turn off the manual power switch immediately, stop operation and contact the after-sale service department. Continued abnormal operation may cause electric shock fire and damage the unit, which may void warranty.
- When the unit needs to be removed or re-installed, please ensure that the work is carried out by qualified professionals. If the installation is not correct, it may cause unit operation failure, electric shock, fire, hurt, leaking, etc.
- Please ensure that any repairs are carried out by qualified professionals: failure to make proper repairs could cause unit operation failure, electric shock, fire, hurt, leaking, etc.
- Do not install the unit near flammable sources, as any leakages could cause a fire.
- Make sure the base on which the unit is installed is strong enough to support it.
- When cleaning the unit, stop operation, switch off the power and disconnect the power.

1.2 DO'S AND DON'TS

DO's:

- Keep your pool chemicals away from the heat pump.
- Keep area clear around heat pump, especially around the fan discharge.
- Regularly clean with microfiber cloth and water.
- Use surface spray around the perimeter of the machine regularly to deter insects. Brush away spider webs if apparent with a soft banister style brush.
- Keep condensation line below the level of the heat pump and ensure good drainage, please refer to page 17 for further information.
- Book annual services to maintain performance.

DONT's:

- Do NOT enclose the unit – this will restrict performance.
- Do NOT use cleaning agents or scourers to clean the heat pump.
- Do NOT leave the controller/touch pad exposed to weather (e.g. rain or water), keep the touch pad inside its protective shroud when not in use.
- Do NOT attempt any repairs as this can void warranty – Contact Green Star Solutions.
- Ensure your heat pump is NOT installed directly against a fence or wall.
- Ensure your heat pump is NOT installed within 1.5m of a gas appliance (e.g. gas hot water system).

Contact **Green Star Solutions** directly with any queries or service needs:

08 9331 3868 or service@greenstarsolutions.net.au

2. HEAT PUMP UNIT WORKING PRINCIPLE

2.1 Heat Pump Operation

Heat pumps use heat from the sun by collecting and absorbing energy from the outside air. This energy is then compressed and transferred to the pool water. Your existing water pump circulates the water through the heat pump, which is normally installed next to the pool filtration system, and the water warms up. The heat pump timer can be set so that the pump operates at the times you want: for example, during daylight hours from 9am to 5pm.

- The unit contains a fan that draws in outside air and directs it over the surface of the EVAPORATOR (energy collector). The liquid refrigerant inside the EVAPORATOR coil absorbs the heat from the outside air and becomes a gas.
- The warm gas inside the coil passes through the COMPRESSOR, which concentrates and increases the heat to form a very hot gas, which then passes through the CONDENSER (water heat exchanger). It is here that the heat exchange occurs as the heat from the hot gas is transferred to the cool swimming pool water circulating through the heat exchanger.
- The pool water becomes warmer and the hot gas returns to its liquid form as it flows through the CONDENSER coil. The gas then passes through the Electronic Expansion Valve and the whole process begins again.
- Developments in heat pump technology mean that today heat pumps can efficiently collect heat from the outside air even when the temperature is as low as 7-10°C. This means that for tropical and subtropical climates the pool can be maintained between 26°C and 32°C.
- See **Figure 1** for diagrammatic explanation.

2.2 Air Source Heat Pump Working Principle

Figure 1

Q_c (Heat energy) = Q_a (Compressor consumption) + Q_b (Heat energy absorbed from ambient environment)

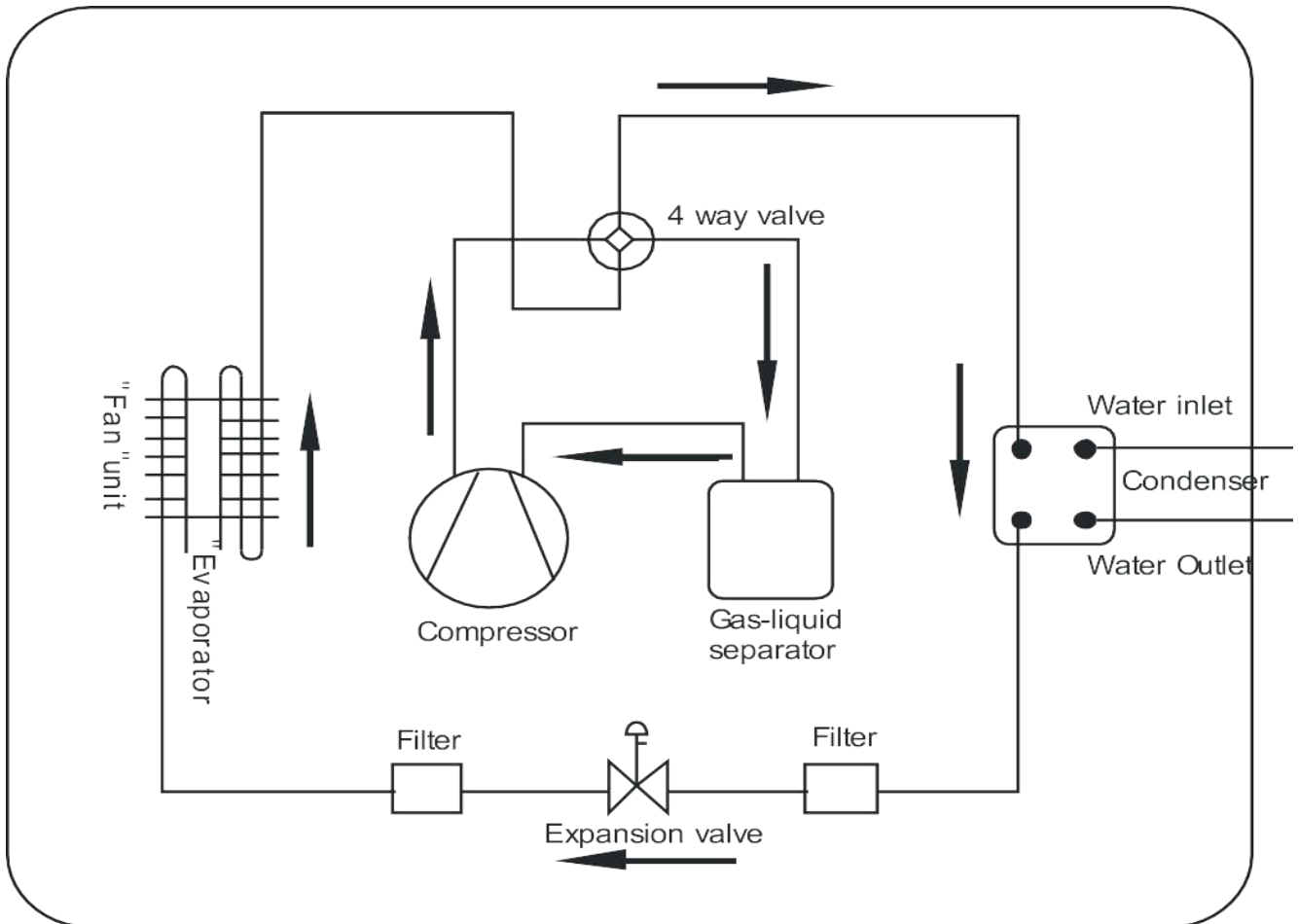

3. GENERAL INFORMATION

3.1 Accessories

After unpacking the unit, please open the accessory box and then check if you have all of the following accessories.

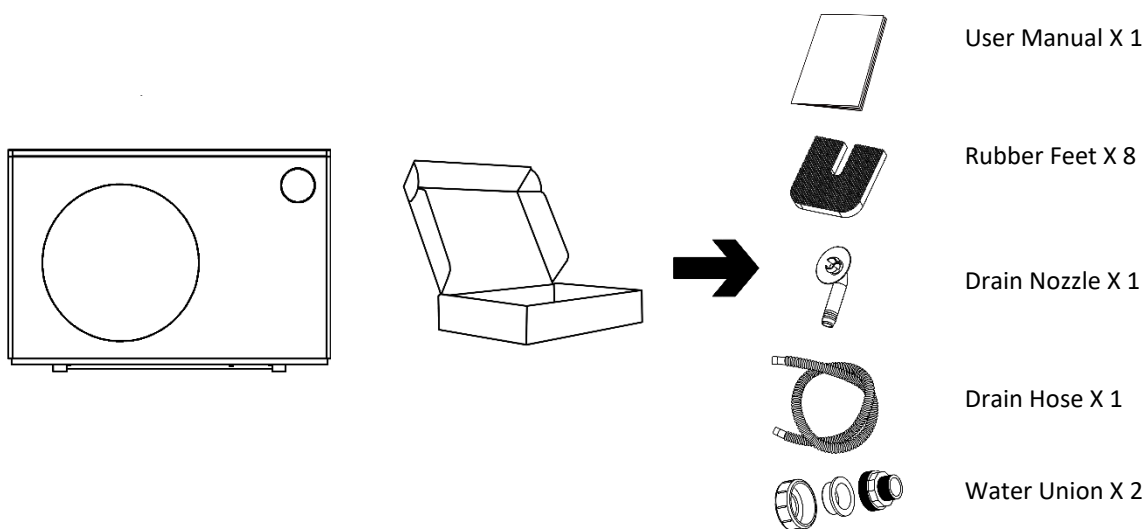

Please keep installation manual safe and read it carefully before using.



The unit must be installed by professional personnel according to the instructions in this manual and in accordance with AS5352:2002 SWIMMING POOL HEAT PUMP SYSTEMS.



WARNING: We recommend that the unit be protected from the risk of lightning strikes or power fluctuations by installing surge protection measures.



WARNING: (Northern Hemisphere only) The unit is not suitable for use in winter: all water must be drained from the unit during winterization or it could freeze inside the unit causing damage to internal components.

3.2 Technical Specification

Table 1

Model No.	GENF	GEN 10F	GEN 13F	GEN 17F
Refrigerant	/	R32		
Power Supply	/	220-240V~/50Hz		
Performance Condition: Air Temperature 27°C, Inlet Water Temperature 26°C, Humidity 80%				
Heating Capacity	kW	10.37	13.57	17.42
COP	W/W	18.08~6.91	18.00~6.96	18.09~6.94
Performance Condition: Air Temperature 15°C, Inlet Water Temperature 26°C, Humidity 70%				
Heating Capacity	kW	7.46	9.87	12.94
COP	W/W	8.32~5.25	8.28~5.17	8.46~5.20
Operating Air Temperature	°C	-10~43		
Rated Power Input at 15°C	kW	0.22~1.42	0.29~1.91	0.35~2.49
Rated Current	A	7.14	9.49	12.02
Advised Water Flow	m ³ /h	3.0	4.0	5.5
Water Pressure Drop	kPa	10	13	16
Water Proof Level	/	IPX4	IPX4	IPX4
Sound Level (1m)	dB(A)	34.9~44.8	35.8~46.2	38.1~48.5
Sound Level (10m)	dB(A)	14.9~24.8	15.8~26.2	18.1~28.5
Water Connection	mm	48.3		

3.3 Technical Specification

Table 2

Model No.	GENF	GEN 21F	GEN 25F	GEN 30F
Refrigerant	/	R32		
Power Supply	/	220-240V~/50Hz		
Performance Condition: Air Temperature 27°C, Inlet Water Temperature 26°C, Humidity 80%				
Heating Capacity	kW	21.46	25.29	30.10
COP	W/W	18.08~6.97	18.00~6.93	18.11~6.97
Performance Condition: Air Temperature 15°C, Inlet Water Temperature 26°C, Humidity 70%				
Heating Capacity	kW	15.96	17.36	22.05
COP	W/W	8.44~5.32	8.41~5.20	8.21~5.18
Operating Air Temperature	°C	-10~43		
Rated Power Input at 15°C	kW	0.43~3.00	0.44~3.34	0.61~4.26
Rated Current	A	14.80	18.50	20.18
Advised Water Flow	m ³ /h	6.5	8.0	9.0
Water Pressure Drop	kPa	20	35	35
Water Proof Level	/	IPX4	IPX4	IPX4
Sound Level (1m)	dB(A)	39.9~49.3	40.8~50.9	40.9~51.5
Sound Level (10m)	dB(A)	19.9~29.3	20.8~30.9	20.9~31.5
Water Connection	mm	48.3		

4. INSTALLATION OF THE UNIT

4.1 Installation Guidelines

- Avoid installations in locations containing pool chemicals such as acid, chlorine, salt.
- Avoid installation in locations where the air contains salt or other corrosive gases.
- Avoid installation in locations with serious power supply voltage fluctuation.
- Avoid installation in unstable places, such as a car or cabin.
- Avoid installation near flammable items.
- Avoid installation in locations with strong electromagnetic forces.
- Avoid installation in locations with harsh environmental conditions.
- Avoid installation of the machine within 2 mtrs or less from a forced water ingress point - for example, a reticulation/sprinkler head.
- Ensure that the unit is installed in accordance to AS5352:2022 SWIMMING POOL HEAT PUMP SYSTEMS.
- Failure to follow these guidelines may void warranty.

4.2 Installation Check

- Check the model, number, name etc. to avoid incorrect installation.
- Make sure there is enough space for installation and maintenance.
- Install in a dry, well-ventilated place ensuring there are no forced water ingress points (like a reticulation/sprinkler head) near the unit and make sure there are no obstructions around the air intake and outlet points.
- Ensure the rubber shock absorber pads are installed and the condensation drain is attached, has a gradual fall and is accessible. As this will need regular checkups/inspections for any blockages or debris build ups.
- Make sure the unit is installed as per **Figure 2. Horizontal Installation Space Requirements** to ensure efficient heating rates.
- Make sure the supporting base is strong enough for the heat pump to sit on and will not subside after install.
- The power supply and diameter of the cables used must be in accordance with the electrical installation requirements, to AS/NZS3000 Electrical Installations.

- Electrical installation must comply with the relevant technical standards of electrical equipment, and electrical insulation work must be done.
- If the unit has been laying down at all, it must be put horizontally for at least eight hours before running.

4.3 Installation Space

Please observe the space requirements indicated below for optimal operation and maintenance.

Figure 2. Horizontal installation space requirements (mm)

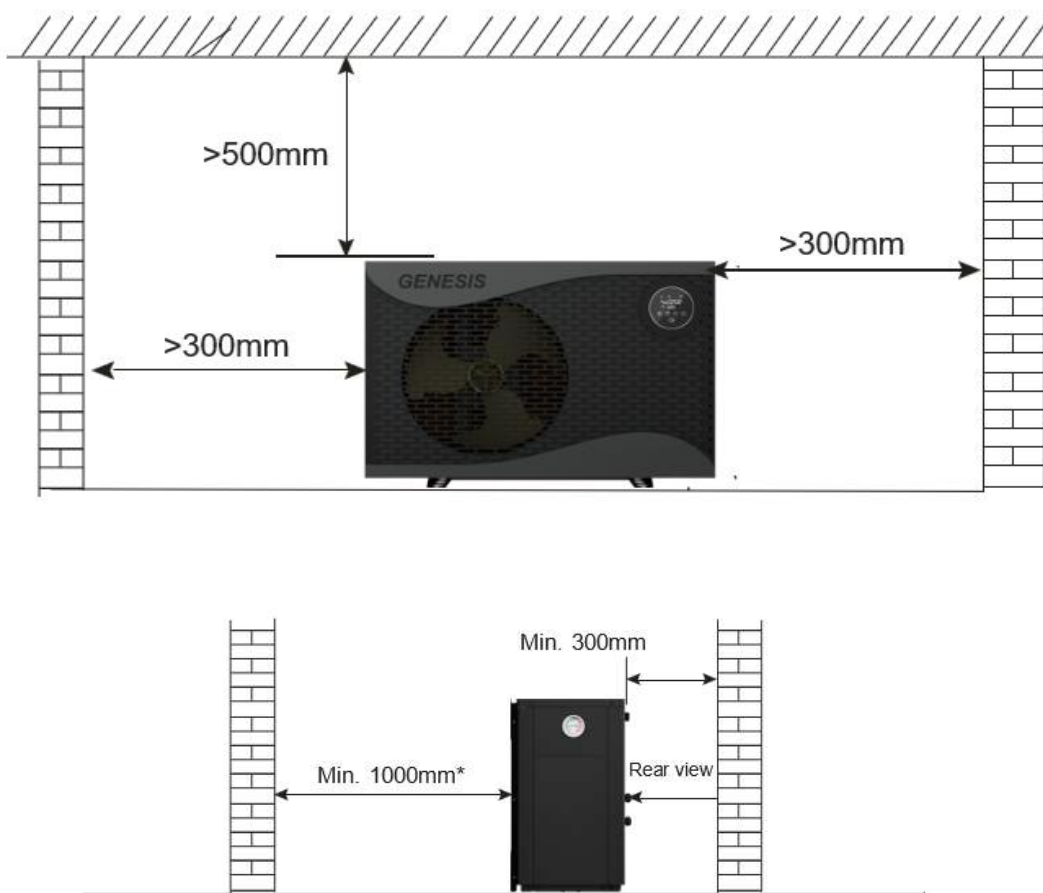

**We recommend 2000mm or greater.*

DO NOT ENCLOSE THE HEAT PUMP.

Installation space continued

1st Case: Single Unit Install

Please note that these are absolute minimum distances and where possible should always have a greater difference. Under no circumstances should any of the distances be reduced as performance will be affected. More ventilation is better.

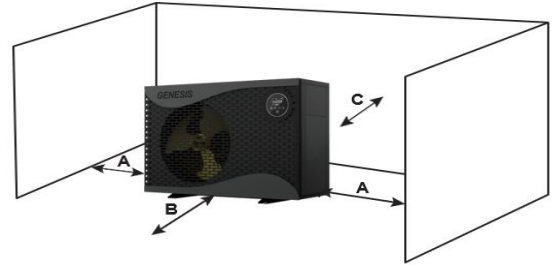

Air is circulated through the back of the heater and then through the sides. Think about where the air flow is going and try to ensure that it does not circulate back through the heater again.

Additional barriers to direct air away from the heater can be used. These units must be installed outdoors in a well-ventilated area, its recommended not to be installed in decks, under houses, in sheds, or any sorts of indoor locations.

Model number	GEN 10F	GEN 13F	GEN 17F	GEN 21F	GEN 25F	GEN 30F
Distance A (mm)	300	300	300	300	300	300
Distance B (mm)	1000	1000	1000	1000	1000	1000
Distance C (mm)	300	300	300	300	300	300

2nd Case: Multiple Unit Install

Please note that these absolute minimum distances and where possible should always have a greater difference. Under no circumstances should any of the distances be reduced as performance will be affected. More ventilation is better.

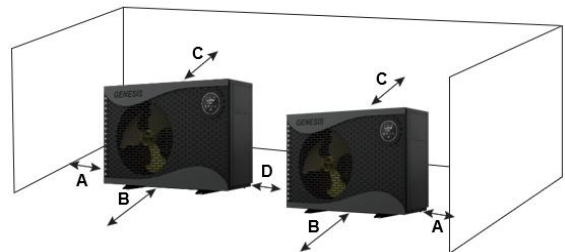

Air is circulated through the back of the heater and then through the sides. Think about where the air flow is going and try to ensure that it does not circulate back through the heater again.

Additional barriers to direct air away from the heater can be used. These units must be installed outdoors in a well-ventilated area, its recommended not to be installed in decks, under houses, in sheds, or any sort of indoor locations.

Model number	GEN 10F	GEN 13F	GEN 17F	GEN 21F	GEN 25F	GEN 30F
Distance A (mm)	300	300	300	300	300	300
Distance B (mm)	1000	1000	1000	1000	1000	1000
Distance C (mm)	300	300	300	300	300	300
Distance D (mm)	1000	1000	1000	1000	1000	1000

4.4. Heat Pump Dimensions

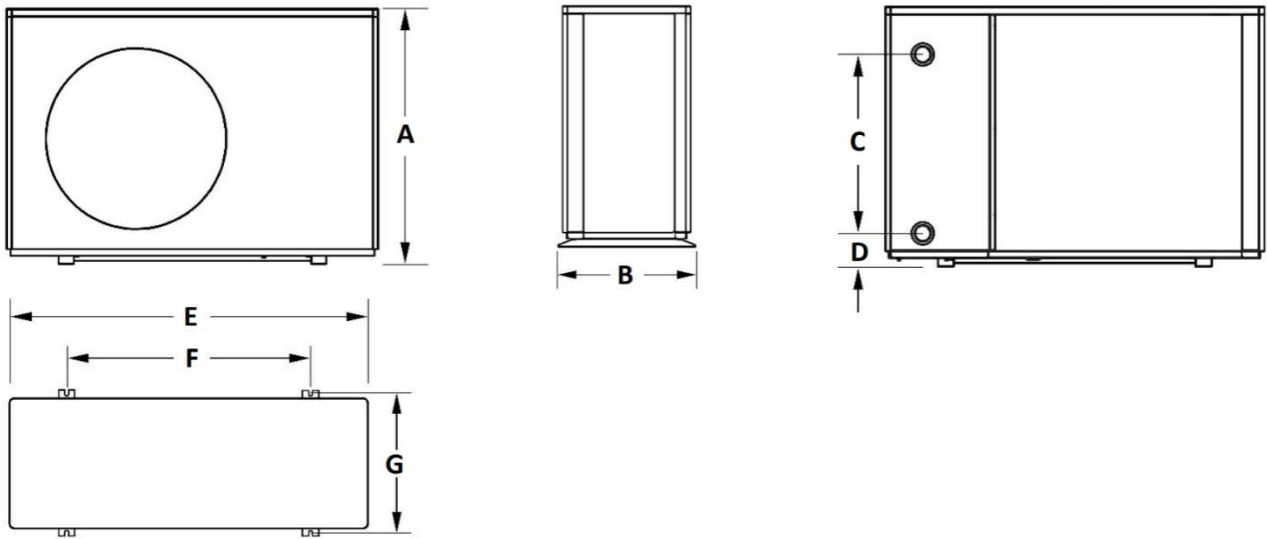

Unit: mm

Model	A	B	C	D	E	F	G
GEN 10F	497	307	245	105	688	450	280
GEN 13F	614	376	330	105	894	525	350
GEN 17F	658	408	380	95	974	610	380
GEN 21F	658	408	380	95	974	610	380
GEN 25F	764	438	520	105	1108	750	410
GEN 30F	764	438	520	105	1108	750	410

4.5 Lifting

- Please use four or more soft lifting belts to move the sets (see Figure 4).
- Please use protective plates on the surface of the units when handling to avoid scratches and deformation.
- Double-check that the support base is strong enough before installing the unit.
- The heat pump will produce condensation water: remember to provide a drainage channel when making the installation base - refer to page 17.
- Please install shock absorbers on the surface of the base.

Figure 4 Lifting Diagram

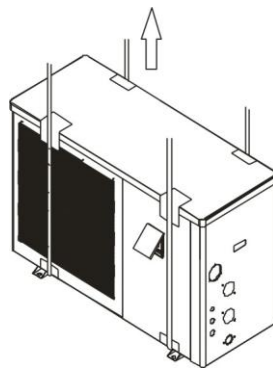

5. INSTALLATION INSTRUCTION

5.1. Transportation

a. When storing or moving the heat pump, always keep it upright and never place it on its side.

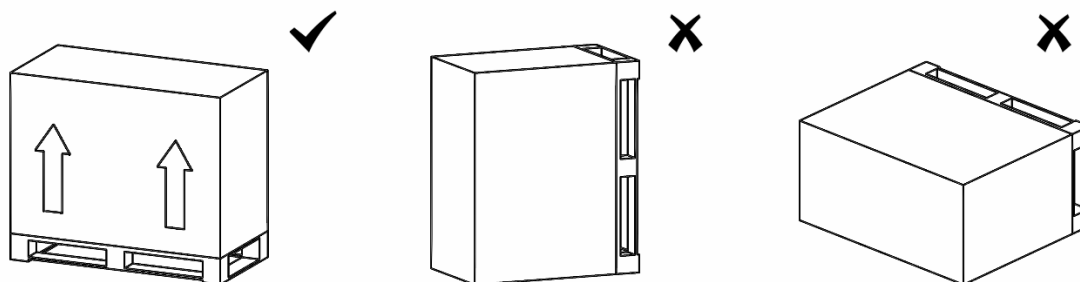

b. When you need to move the heat pump, do not lift the water pipe joint, otherwise the internal titanium heat exchanger will be damaged.

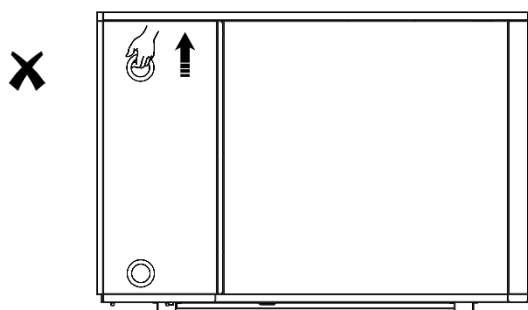

5.2. Installation of Drain Pipe

Attach the drain pipe to the drain port on the bottom of the heat pump and ensure the line stays below the unit for proper gravity drainage. Keep the drain free of blockages.

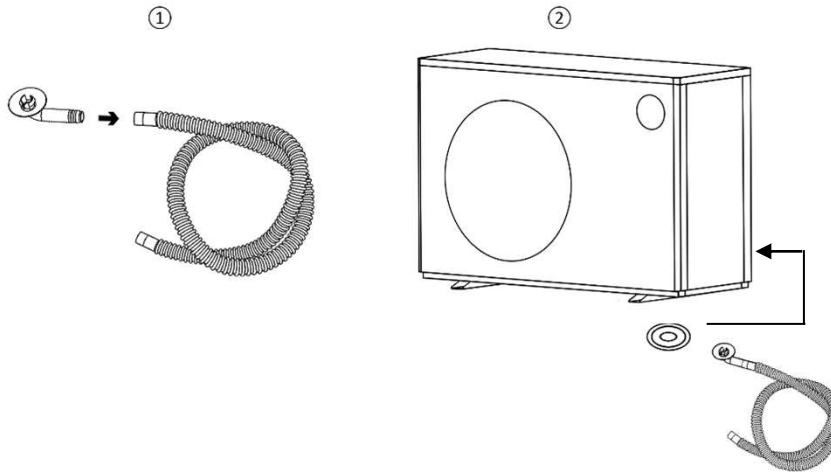

Installing the condensation drain is important for several reasons.

1. **Heat pumps produce a lot of condensation** as they pull heat from the air. During this process, moisture in the air condenses on the evaporator coil depending on the humidity level. Without the drain, this water will simply spill onto the ground.
2. **Prevents flooding and property damage.**
 - Collected condensation can:
 - Create muddy or flooded areas around the unit
 - Undermine the concrete slab.A proper drain directs water safely away from the unit.
3. **Prevents corrosion and premature equipment failure.** Standing water around the base of the unit can cause the following:
 - Rust or premature corrosion on the metal base pan
 - Mold growth inside the cabinet
 - Degradation of components near the bottom of the unit.The drain keeps the equipment dry and extends its life.
4. **Improves performance and air flow.**
 - Pooling water can attract debris, leaves, or dirt that gets drawn into the unit and clogs the condensing fins.A clean dry area ensures the system gets proper air flow, which maintains efficiency.
5. **Required by manufacturer.** We require the drain line be installed to maintain warranty coverage.

5.3. Installation of Water Union

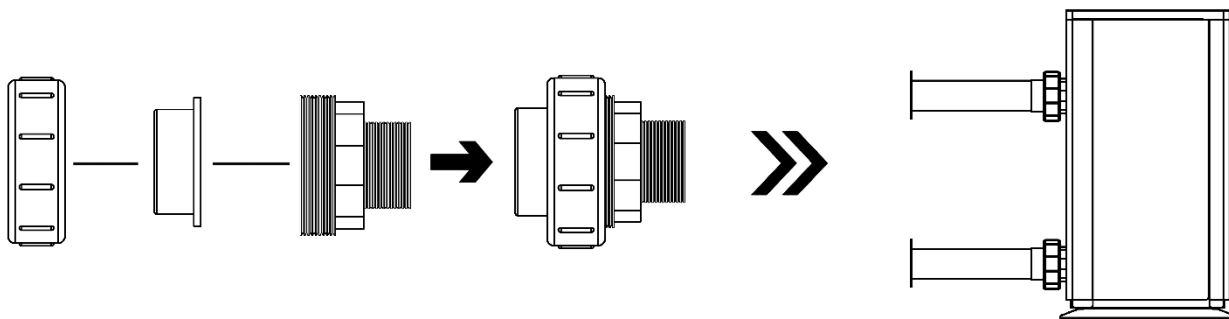

5.4. Installation of Water Pipe

- Prevent air, dust and other material from going into the water pipes.
- Fix the whole system before installing the water pipes.
- Make sure that there is a stable water flow, to prevent excessive throttling.
- Do not handle, move or lift the unit by holding the water inlet and outlet pipe: use only the holes on the beam of the base.
- When connecting water pipes, use hard pipes rather than flexible hoses, as hoses will increase the resistance of the pipes.

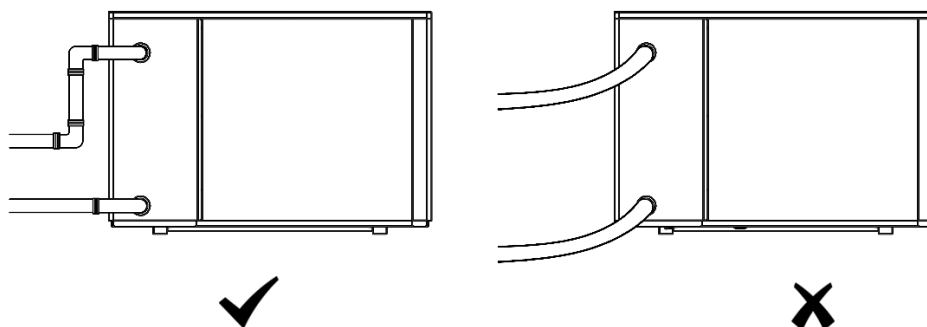

5.5 Installation Options

1. Inline with Filtration

The heat pump is activated by the flow of water initiated from the filtration/circulation pump, if the heater gets to temperature within the timers the unit will first start to use the inverter technology to slow the machine down to maintain the temperature and eventually to a stop

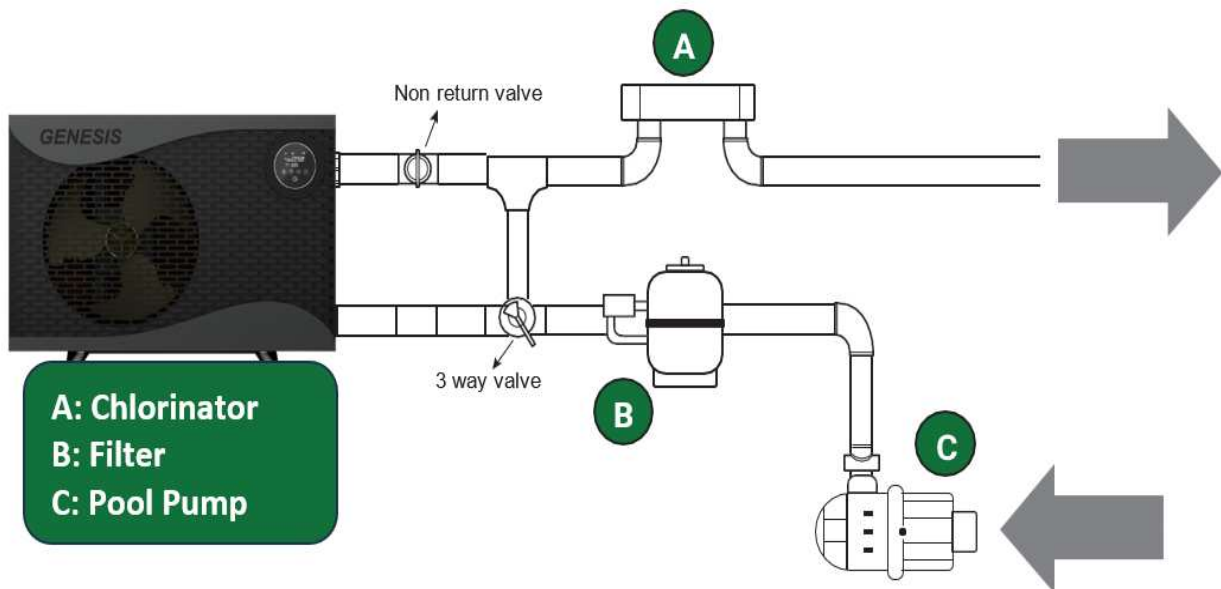

1. Chlorinator controller initiates the filtration pump either manually or through a timer.
2. Heat pump's flow switch senses the water flowing through the heat pump.
3. Heat pump starts and will run until temperature is reached or filtration pump switches off
4. No additional settings needed to be changed.
5. If the circulation pump is not running and no flow is detected, the unit will display E26 – this is normal and an indication the unit is sitting idle waiting for the filtration pump to start again.
6. If the pool temperature is not reached within the filtration times you may need to extend the timers to match the heating requirement.

2. Independent Install

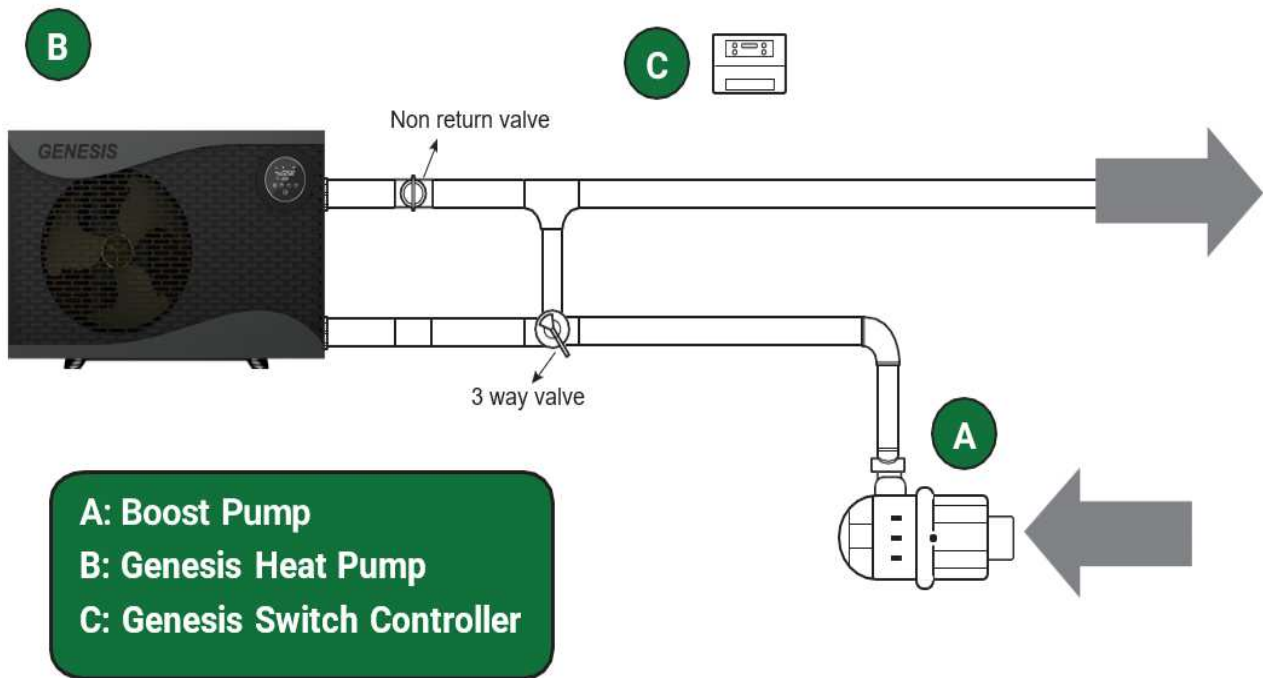

1. See Boost Pump installation manual for more information on commissioning and how to set the pump. (pump should be in normally off state for activated control)
2. Once temperature is reached or the timer is finished the heat pump will switch off the relay output, stopping the circulation pump.
3. If the pool reaches temperature but the timer is still active the heat pump will switch off the relay to stop the circulation pump.

5.6 Connection Sizes

<i>Model No.</i>	<i>Inlet</i>	<i>Outlet</i>
GEN 10F GEN 13F GEN 17F GEN 21F GEN 25F GEN 30F	DN40	DN40

- The pipe pressure and flow rate should be calculated before selecting the diameter of the pipe, pressure drop range is 0.3 - 0.5 kgf/cm²(3 - 5m) head pipe flow rate range is 1 .2 -2. 5 m/s.
- The hydraulic calculation should be made after selecting the pipe diameter. If the resistance is more than the pump head, then a more powerful pump or larger pipes are required.

5.7 Required Water Quality

- Bad quality water will produce more lime scale and sand: this kind of water should be filtered and demineralized.
- The water quality should be analyzed before operating the unit: PH value, conductivity, Chloride ion concentration and sulphate ion concentration should be checked.
- Acceptable water quality shown below:

<i>PH value</i>	<i>Total hardness</i>	<i>Conductivity</i>	<i>Sulphate ion</i>	<i>Chlorine ion</i>	<i>Ammonia ion</i>
7"--'8.5	< 50ppm	<200μV/cm(25°C)	None	< 50ppm	None
Sulfate ion	Silicon	Iron content	Sodium	Ca	
< 50ppm	< 50ppm	< 0.3ppm	No requirement	< 50ppm	

- Suggested filter mesh = 40.

6. ELECTRIC INSTALLATION

(1) Wiring Precautions

For safe operation and to maintain the integrity of the electrical system, wiring must be conducted in accordance with the following regulations:

- a. Wiring must be connected by professional technicians according to the wiring diagram.
- b. The heat pump must be connected to an appropriate circuit breaker in accordance with the current standards and regulations of the country where the system is installed.
- c. Connect to a suitable power supply, and the voltage should comply with the rated voltage of the equipment.
- d. For three-phase systems, they must be connected in the correct phase sequence. If the phases are reversed, the heat pump compressor will not work.
- e. Make sure the heat pump is well grounded.
- f. The power supply cable must be suitable for the rated power of the equipment and the wiring length required for the installation. The cable must be suitable for outdoor use.
- g. In places open to the public, an emergency stop switch must be installed near the heat pump.
- h. Power cords and signal lines should be arranged neatly and not affect each other.

The recommended cable specification of each model is shown in the following table.

Model	Power Supply	Cable Specification (Max. Recommended Value)
GEN 10F	220-240V~/ 50Hz	3G 1.5mm ²
GEN 13F		3G 2.5mm ²
GEN 17F		3G 2.5mm ²
GEN 21F		3G 2.5mm ²
GEN 25F		3G 4.0mm ²
GEN 30F		3G 4.0mm ²

(2) Wiring Instruction

WARNING: Power to the heat pump must be disconnected before performing any wiring work.

Follow the instructions below to connect your heat pump with cables.

Step 1: Use a screwdriver to remove the **side panel** of the device for wiring.

Step 2: Connect the cable to the corresponding port of the heat pump as shown below.

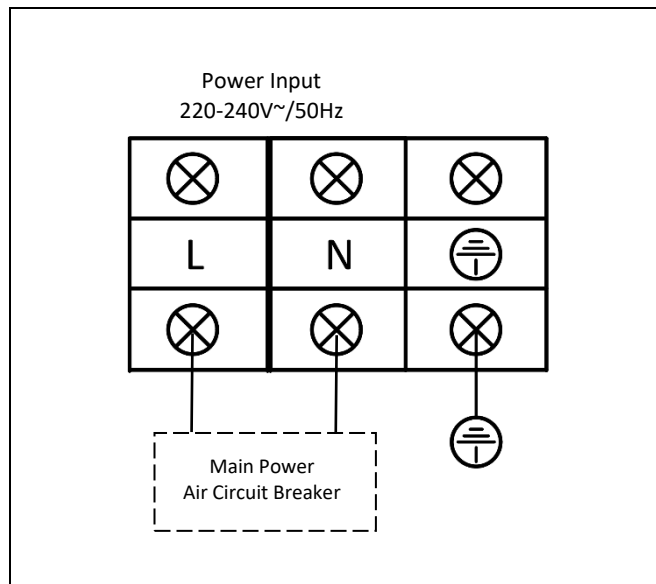

If a water pump needs to be connected to the water pump port, make sure to connect a relay, otherwise the circuit board may be damaged!

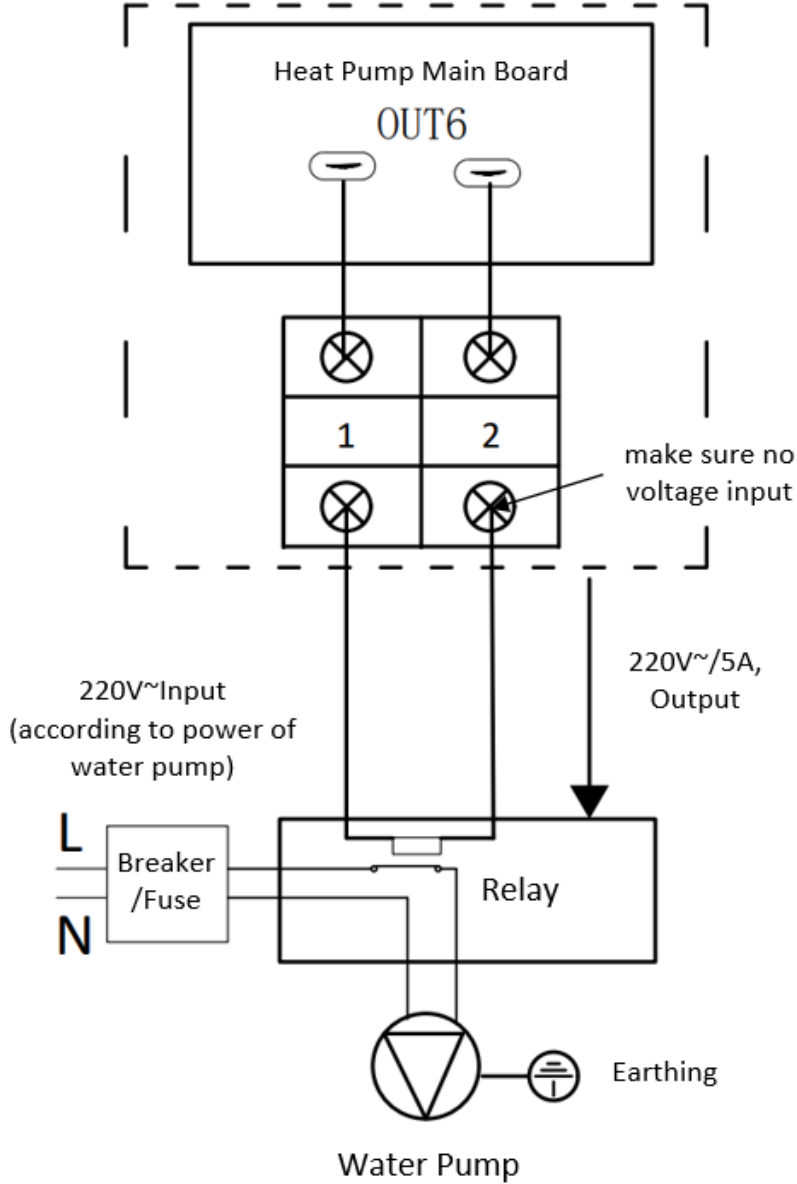

* For port 3 and 4, make sure to connect a relay with them, and no voltage input, otherwise the circuit board may be damaged!

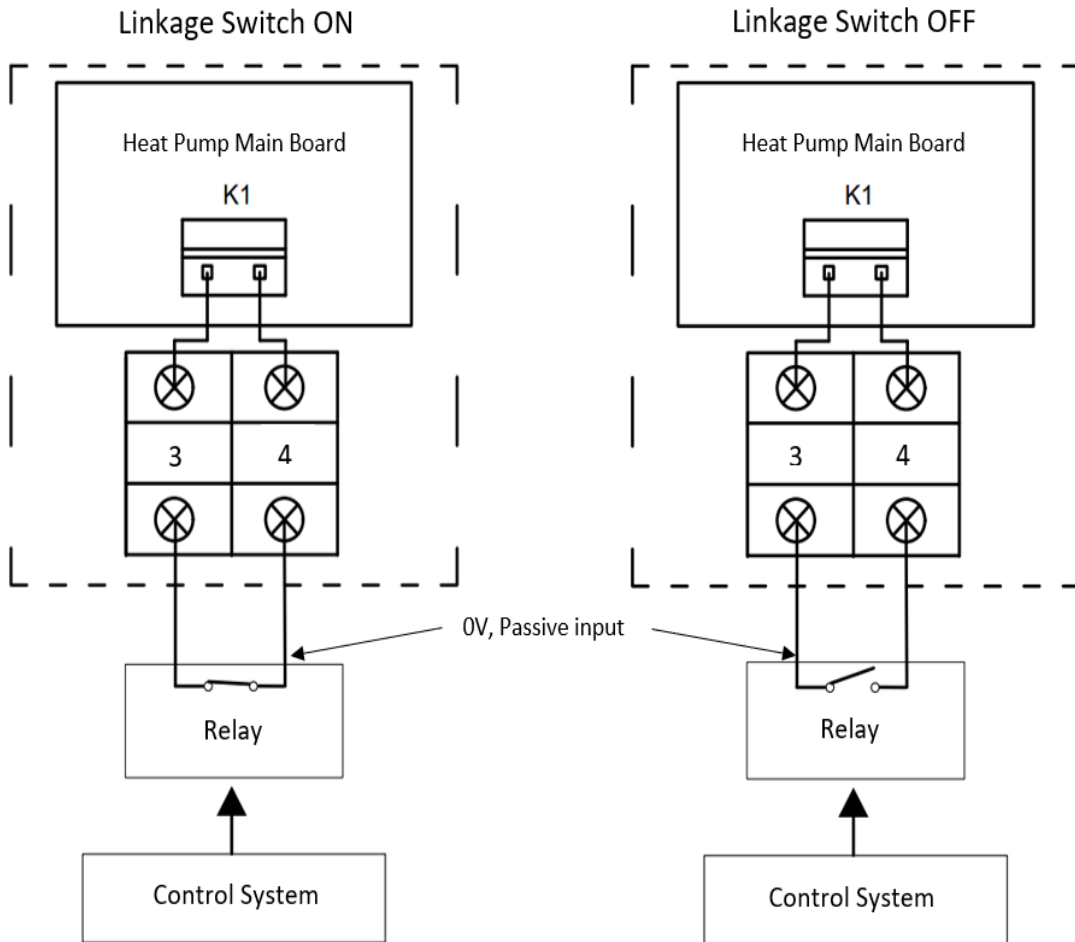

If the control system controls the relay to be closed, port 3 and 4 are closed. Then the heat pump is turned on.

If the control system controls the relay to be disconnected, port 3 and 4 are disconnected. Then the heat pump is turned off.

7. INSTALLATION OF OPTIONAL ACCESSORIES

7.1 Selection of the Water Pump

- The circulation pump is required for the system to operate, there is a terminal connection for the pump (single phase).

⚠ NOTE *For single-phase pumps please check the wiring diagram.*

- Head of circulation pump = height difference between water level and main unit + total pipeline resistance (determined by the hydraulic calculation) + pressure loss of main unit (see nameplate on heat pump).

⚠ NOTE *Multiple units are installed in parallel place more demand on the water pump requirement.*

8. TESTING

8.1. Initial Inspection

Make sure that the following items are complied with.

- a. The heat pump is installed correctly.
- b. Pipes and wires are connected correctly.
- c. The power supply voltage is the same as the rated voltage of the unit.
- d. The leakage protector works normally.
- e. The ground wire is connected correctly.
- f. Drainage is smooth and there is no water leakage.
- g. Pipe insulation is completed.
- h. The air in the duct has been exhausted.
- i. Refrigeration pipes or components are not installed in corrosive environments.

8.2. Leakage Detection

All the following operations must be performed by professionals.

- a. It is prohibited to use fire sources during leak inspection.
- b. Leak detection fluid is suitable for most refrigerants, but chlorine-containing cleaners cannot be used because chlorine may react with the refrigerant and corrode the copper pipes.
- c. Leak inspection must be done in a ventilated area. It is prohibited to detect the leakage in closed areas.
- d. When refrigerant leakage occurs, stop using the equipment immediately and contact the service center professionals.
- e. If welding is required, complete vacuuming is required before welding.

8.3. Trial Operation

Step 1: The user must turn on the water pump first and then the heat pump. Turn off the heat pump first, then the water pump. Otherwise, the equipment will be damaged.



Step 2: Before starting the heat pump, check for water leaks, set the appropriate temperature, and then turn on the power.

Step 3: Check the following items during trial operation.

- a. Is there any abnormal noise or vibration during operation?
- b. Is there any leakage in the entire gas system?
- c. Are all the keys of wire controller normal?
- d. Is the display of wire controller normal?
- e. Is the current normal?
- f. Is the condensed water discharge normal?

9. WORKING MODE

In order to realize a better user experience, the heat pump is equipped with three working modes – Boost, Smart and Silence. For every mode, the machine’s frequency can be automatically adjusted based on the air temperature and water temperature. To better understand these three modes, please check the following advantages of them.

Mode		Advantage
	Boost	Maximize the performance of the heat pump and realize rapid heating or cooling.
	Smart	This mode can be used if rapid heating or cooling is not required, achieving more energy-saving effect.
	Silence	Achieve a silent state of the heat pump, with the best energy saving effect, while also maintaining water temperature.

10. OPERATION





10.1. Overview of Wire Controller









10.1.1. Icon

Icon	Meaning	Icon	Meaning
	Auto Mode		Degree Celsius
	Cooling Mode		Degree Fahrenheit
	Heating Mode		Boost Mode
	Defrosting Mode		Smart Mode
	Fault or Protection		Silence Mode
	Wi-Fi		Time or Parameter
	Set Water Temp.		TIMER ON/OFF
	Current Water Temp.		Lock

10.1.2. Key



No.	Key	Meaning	Function
1		Mode 1	Switch between Auto, Cooling and Heating Mode
2		Mode 2	Switch between Boost, Smart and Silence Mode
3		Up	Increase the Value
4		Down	Decrease the Value
5		Power	Press to turn On or Off the heat pump; Press and hold for 3 seconds to lock or unlock the wire controller

10.1.3. Keys Combination

No.	Combination	Function
1	Press the keys "  " and "  " and then hold for 2 seconds	Enter Parameter Checking Interface
2	Press the keys "  " and "  " and then hold for 2 seconds	Enter Timer Setting Interface
3	Press the keys "  " and "  " and then hold for 3 seconds	Search for a Wi-Fi Signal and Connect to Wi-Fi

10.2. Operation of Wire Controller

10.2.1 Power

Press the key “” to turn on or off the heat pump. Press the same key “” and then hold for 3 seconds to lock or unlock the wire controller.



When the wire controller is locked, the icon “” is displayed on the screen.

The wire controller will be automatically locked after 120 seconds of inactivity.

10.2.2 Mode

a. Heating/Cooling/Auto

When the heat pump is on, press the key “” to switch between modes:

Heating “” Cooling “” and Auto “”

Note: When Auto mode is chosen, the icon “” will be displayed. In this mode, the heat pump intelligently chooses the most appropriate operating mode according to the setting water temperature and the current water temperature:

When executing Auto Heating mode, both icons “” and “” will be displayed; When executing Auto Cooling mode, both icons “” and “” will be displayed.

b. Boost/Smart/Silence

When the heat pump is on, press the key “” to switch between modes:

Boost “”, Smart “” and Silence “”

10.2.3 Temperature Setting



When the heat pump is on, press the keys “” or “” to adjust the setting water temperature under current mode.

The setpoint can be seen in this area “ 26.0”.

And the real-time current water temperature is shown in the area “ 25.8”

For rapid adjustment, press the key “” or “”

10.2.4 Wi-Fi Connection

Press both keys “” and “” and then hold for 3 seconds to connect to Wi-Fi.

The icon “” will be flashing during connecting.



This icon will remain displayed after successfully connected.

10.2.5. View Operating Parameters

a. The way to enter the interface of operating parameter:

Press the keys “” and “” then hold for 2 seconds.

Then the code of operating parameter is shown in the timing display area, and parameter content is shown in the current water temperature display area.

b. The way to view the operating parameters: After entering the parameter interface, press the key “” or “” to view the operating parameters.



To exit this interface, press the key “”.

If no operation for 120 seconds, it also exits automatically.

List of Operating Parameter

Code	Parameter Name	Unit	Scope	Remark
01	Practical Frequency of Inverter Compressor	Hz	0~130	
02	AC Current	A	0~50	
03	AC Voltage	V	0~300	
04	DC Voltage	V	0~500	
05	Inlet Water Temperature	°C	0~40	
06	Outlet Water Temperature	°C	0~40	
07	Water Tank Temperature	°C	0~40	Not for pool heat pump
08	Tube in Shell Heat Exchanger Temperature	°C	0~40	Not for pool heat pump
09	Outdoor Coil Temperature	°C	-30~150	
10	Outdoor Air Temperature	°C	-30~43	
11	Gas Suction Temperature	°C	-30~70	
12	Gas Exhaust Temperature	°C	0~150	
13	Water Inlet Temperature of Plate Heat Exchanger	°C	0~40	Not for pool heat pump
14	Outlet Water Temperature of Titanium Heat Exchanger	°C	0~40	Not for pool heat pump
15	Step of Electronic Expansion Valve in Main Circuit	P	0~500	Number of pulses
16	Step of Electronic Expansion Valve in Auxiliary Circuit	P	0~500	Not for pool heat pump
17	IPM (Driver Module) Temperature	°C	0~150	Reserved (default value: -30)
18	Speed of DC Fan Motor	RPM	0~900	







10.2.6. Fault and Protection

When the fault or protection occurs, the corresponding codes flash in the timing area and the icon “  ” is displayed. After this status is eliminated, the codes and icon “  ” disappear.

List of Fault and Protection

Code	Description	Remark
E01	IPM (Driver Module) Protection	
E02	AC Voltage Over/Shortage Protection	Input voltage inspection
E03	AC Current Over High Protection	
E04	Gas Exhaust Temperature Over High Protection	
E05	Outside Coil Temperature Over High Protection	
E06	Compressor Drive Protection	
E07	Air Temperature Sensor Fault	
E08	Outside Coil Temperature Sensor Fault	
E09	Gas Exhaust Temperature Sensor Fault	
E10	Bus Voltage Over/Shortage Protection	Voltage protection after rectification
E11	Current Sensor Fault	
E12	Compressor Driver Communication Fault	
E13	DC Fan Motor Fault	
E14	Gas Suction Temperature Sensor Fault	
E15	Driver's EE Fault	
E16	Main Control Board's EE Fault	
E17	Low Pressure Protection	
E18	High Pressure Protection	
E19	IPM Temperature Over High Protection	
E20	Power Off Suddenly	Automatic power on after recovery
E21	Evaporation Temperature (T2) Over Low Protection	
E22	Communication Error between Wire Controller and Main Control Board	
E23	Phase-shortage Protection	
E24	Inlet Water Temperature Sensor Fault	
E25	Outlet Water Temperature Sensor Fault	
E26	Water Flow Switch Fault	Refer to pages 19 - 20
E27	Inadequate Water Flow Protection	
E28	Outlet Water Temperature Over High Protection in Heating Mode	
E29	Outlet Water Temperature Over Low Protection in Cooling Mode	
E30	Evaporation Temperature Sensor (T2) Fault	
E33	PFC Hardware F0 Error	Driver error
E34	PFC Software Over Current Protection	Driver error
E35	Compressor Step-lost	
E37	Compressor Startup Failure	







10.2.7. Clock Setting





- a. The way to enter clock setting interface: Press the key “” and then hold for 3 seconds till the number in hour part of timing area flashes. Then the clock setting interface is entered.
- b. The way to set the clock: When the number in hour area is flashing, it means it is adjustable. Press the key “” or “” to adjust Hour; Then press the key “” to confirm and switch to Minute part. Repeat above sets to set the minute. After finishing setting, press the key “” to save it and then press the key “” to exit the setting interface.





10.2.8. Power ON/OFF Timer Setting

- a. Users can set up two groups of timers to automatically turn ON or OFF the heat pump. If the timers of power ON and OFF are set to be the same, the setting will become invalid.

b. Power ON/OFF Timer Setting Method

Press the keys “” and “” and then hold for 3 seconds till the icons “” and “**1**” are displayed on the screen. When the icon “**1**” is flashing, press the key “” or “” to select group NO.1 or group NO.2 of timer, and then press the key “” to confirm.

When the number in Hour area is flashing and the icon “**ON**” is displayed, press the key “” or “” to set the hour of timing ON of group NO.1 (or NO.2) Then press the key “” to confirm and switch to set the minute while the number in Minute area is flashing. Repeat the above steps and then press the key “” to confirm.

- c. After finishing the setting of the group NO.1 (or NO.2) timing ON, it will automatically switch to the timing OFF setting interface. When the icons “**1**” (or “**2**”) and “**OFF**” are displayed, press the key “” or “” to set the hour of timing OFF of group NO.1 (or No.2). Then press the key “” to confirm and switch to set the minute while the number in Minute area is flashing. Repeat the above steps and then press the “” to confirm.



- d. The way to exit the interface of timer ON/OFF setting: Short press the key “” during setting, the setting interface will be exited and the current setting will no longer be saved.

- e. The way to cancel timer ON/OFF setting: When entering timer group NO.1 (or NO.2) setting interface, press the key “” and then hold for 3 seconds to cancel the current timer group (NO.1 or NO.2).

10.3. Connection and Operation of APP

10.3.1. APP Download

Search “Smart Life” in app store of your mobile phone and then download it.

App Icon	iOS system download it from:	Android system download it from:
 Smart Life		

Or you can download the app from scanning the following QR code.



Note: For Android mobiles, it is necessary to activate the option of "Download apps from external sources".

Open the APP and activate the authorization of its positioning.

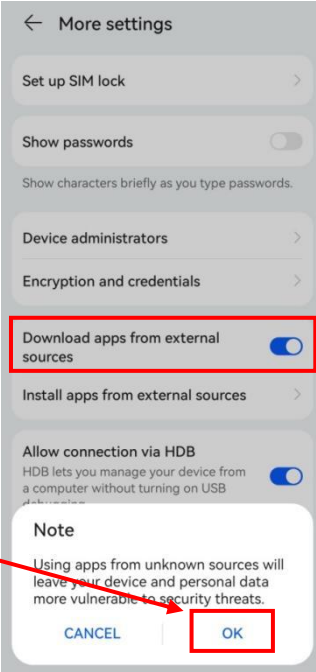

10.3.2. User Registration

(1). For new user, tap the following “Sign Up” button to register a new account.

(2). Follow the instruction to finish your registration.

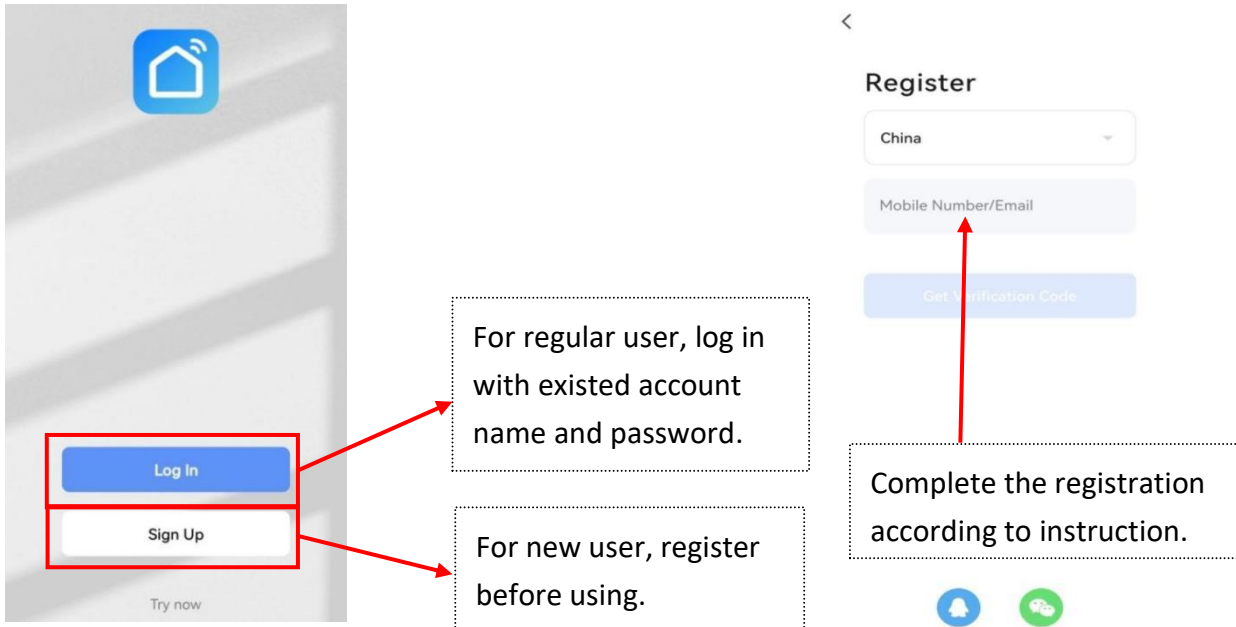

10.3.3. User Login

Select your location, enter the account name and password, and then agree the Privacy Policy.

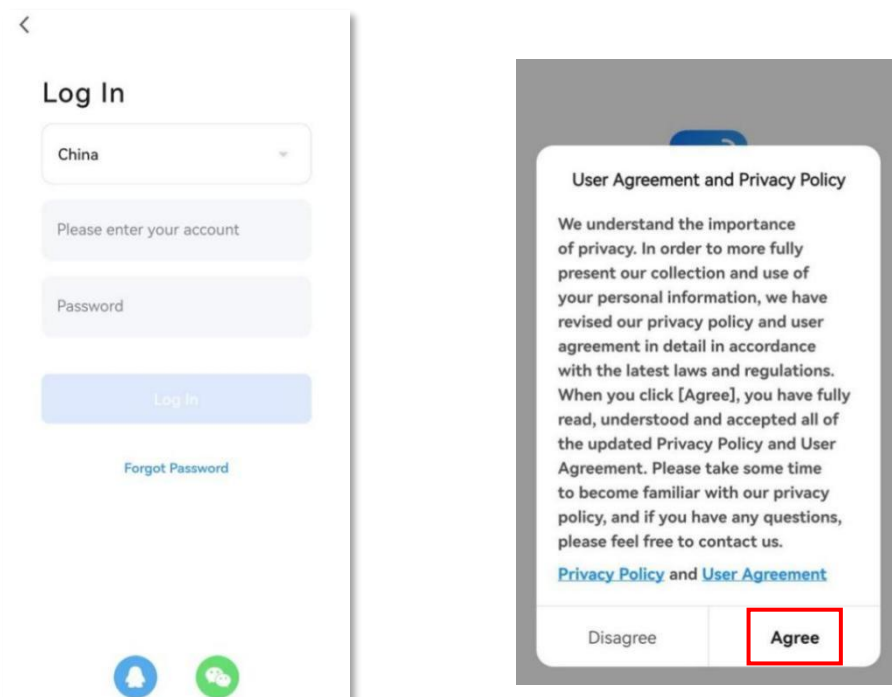

Connect your mobile phone to the accessible Wi-Fi (**the one that the heat pump device is connected to**). Additionally, keep Bluetooth of your mobile phone on during this process.

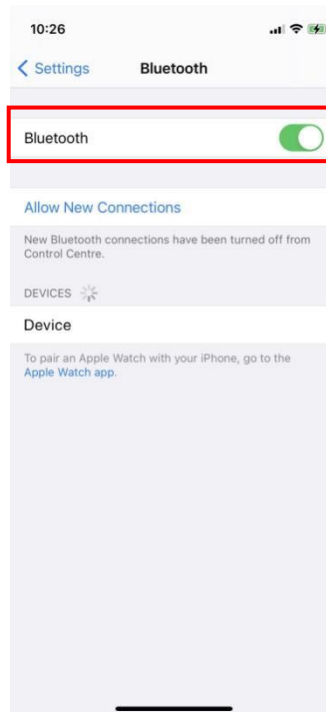
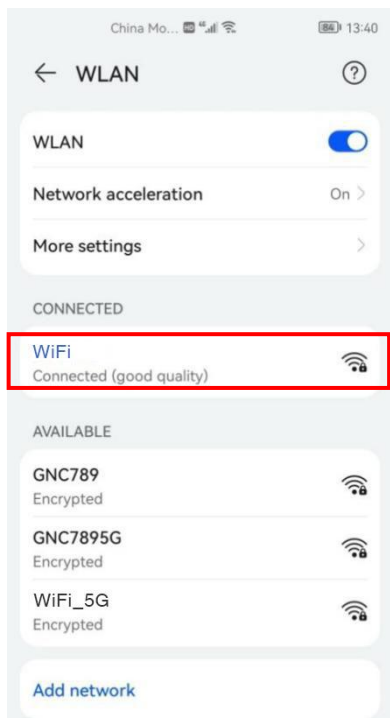

Make sure your Location Services on your smartphone are kept "On" and also enable "Allow Apps to Request to Track".

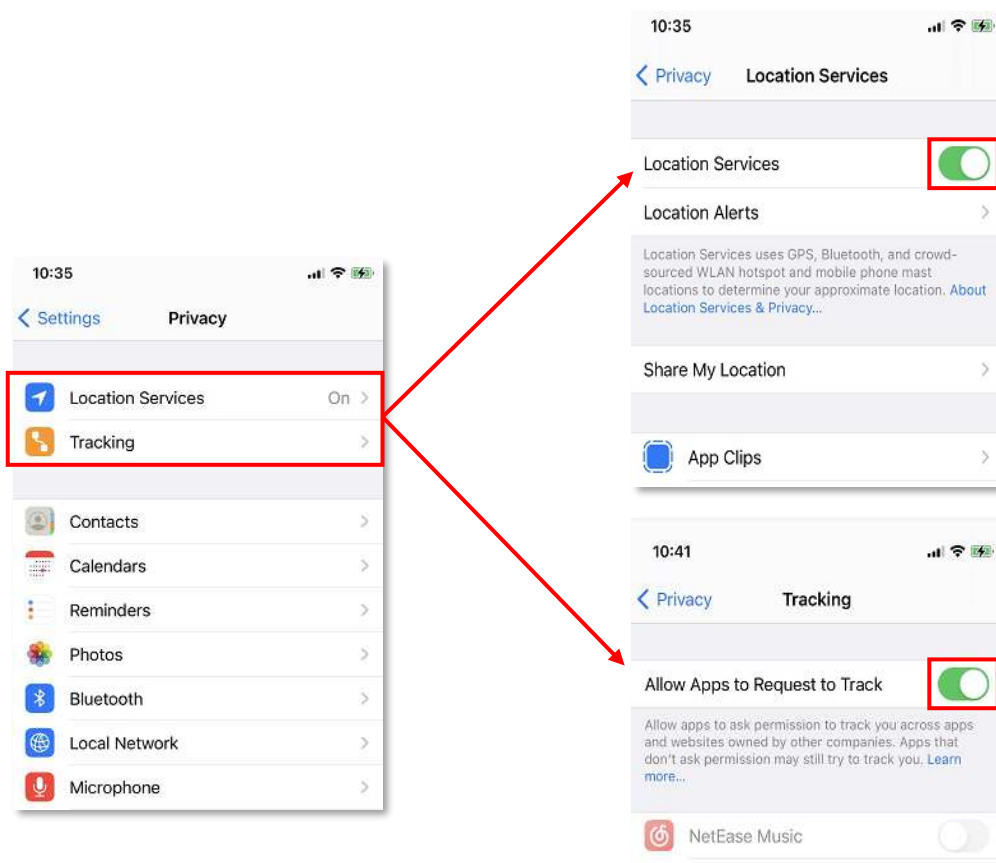

10.3.4. Add Device

Tap the button “+” at the right upper corner, or tap button “Add device” to add the smart device you want to connect.

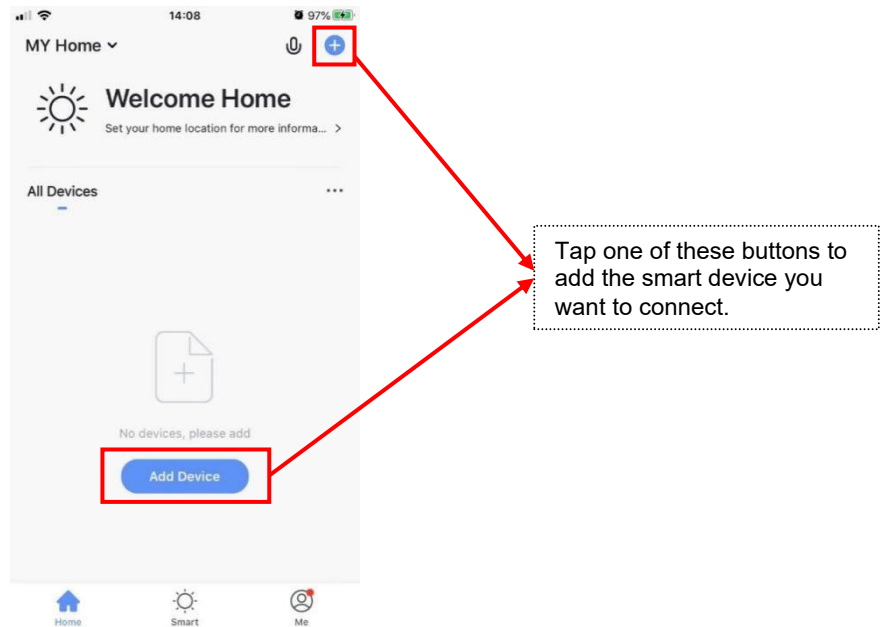

Select “Others” to enter the “Add Manually” interface. And then select “Others (Wi-Fi)”.

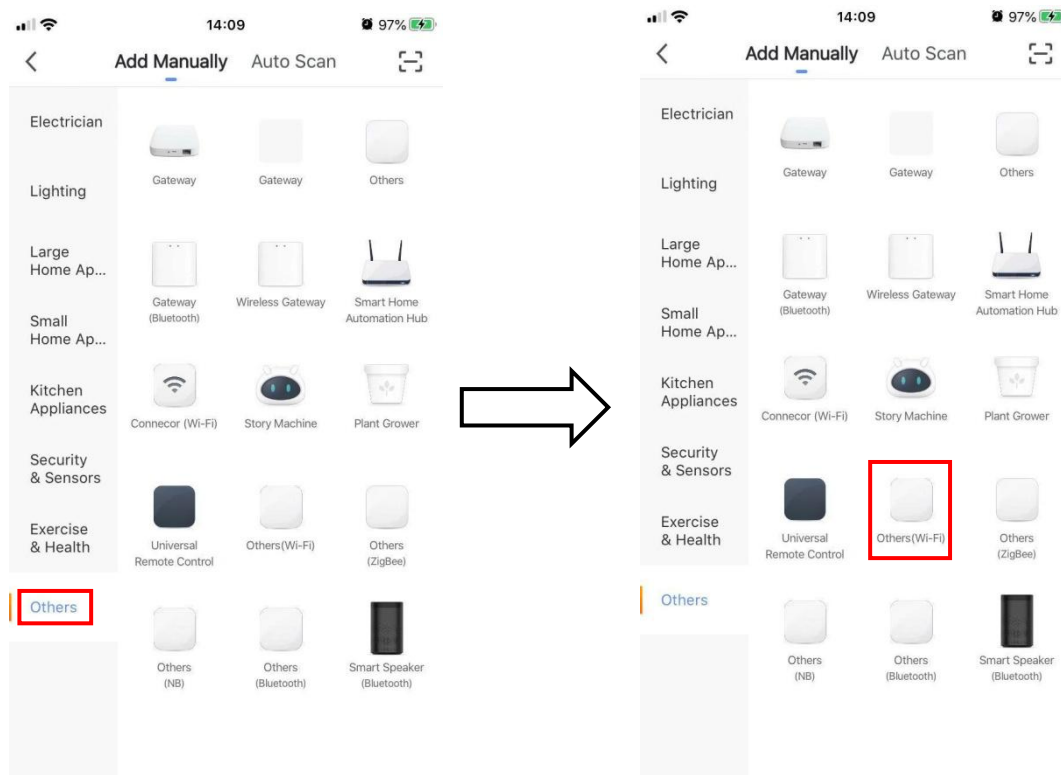

Then enter the account and password of the Wi-Fi (the same Wi-Fi source as the heat pump device connects) in following new interface:

After entering the above information, tap the button “Next”.

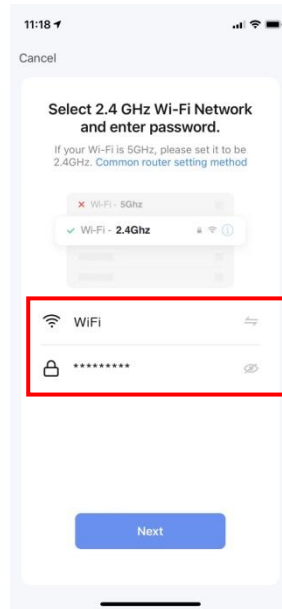

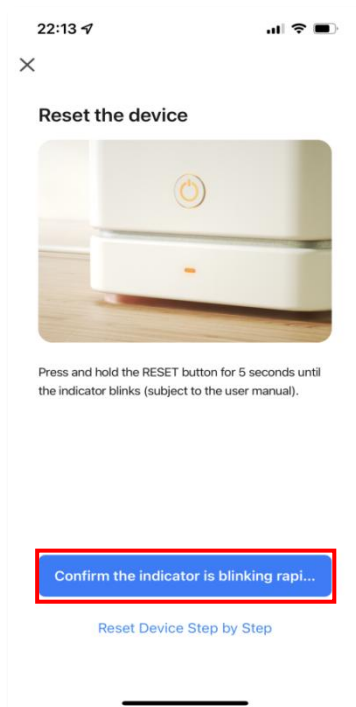

10.3.5. Connection

When you enter this interface, tap button below.



Then, operate the controller of the heat pump according to the following instruction:

Press these two buttons  and  at the same time until the icon  on the right upper corner starts to flash.

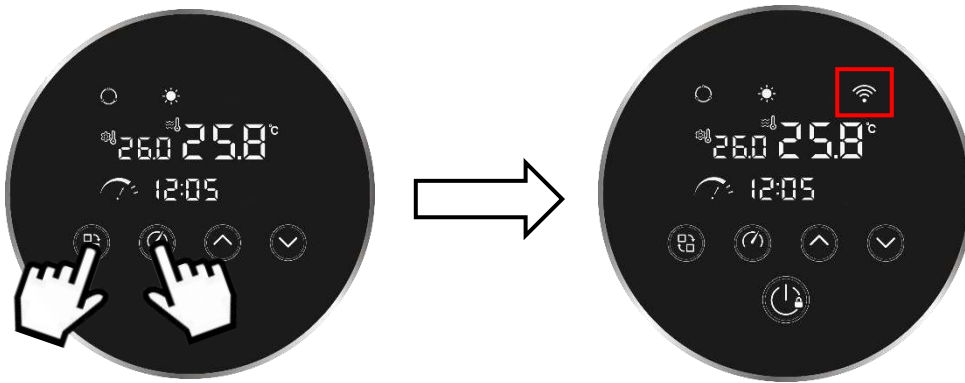

Scene 1:

If the icon  flashes slowly, tap the following button “Blink Slowly” on your mobile phone.

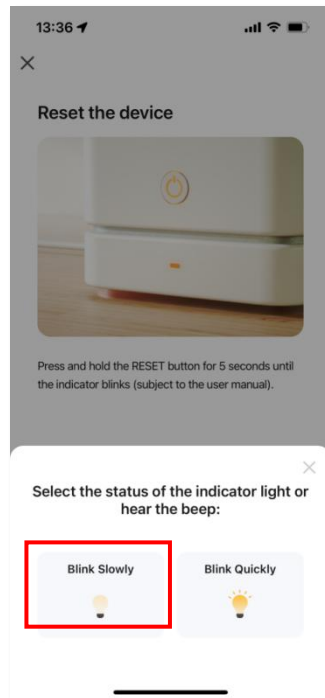

And then tap the following button in the new interface.

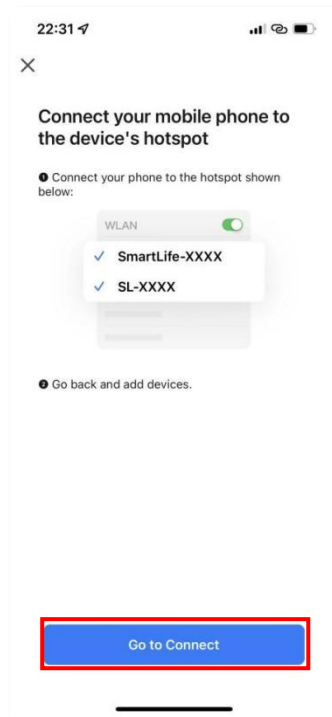

Select the WLAN source of "SmartLife-XXXX" ("XXXX" will be random combination of letters and numbers). And then get back to the Smart Life app.



When the following page appears, it indicates that your mobile phone is scanning for the hotspot signal from the wire controller of the heat pump.

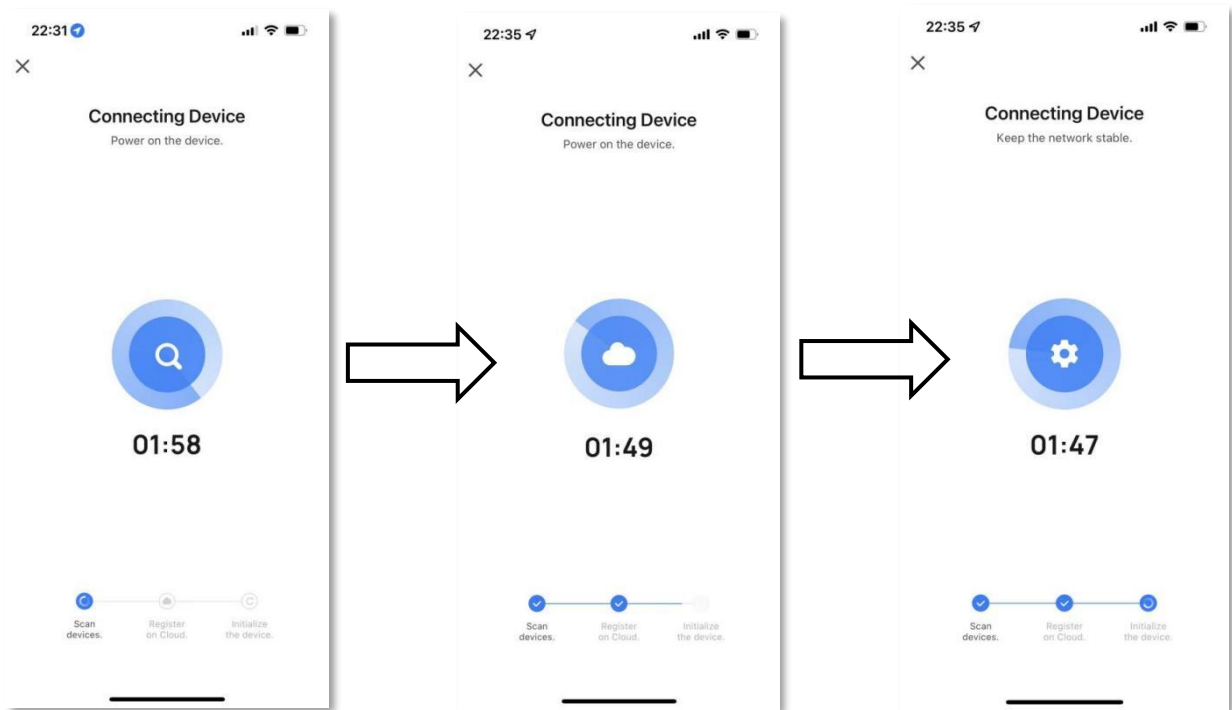

Upon the appearance of this page, it implies that the connection has been established successfully. Subsequently, tap on the button "Done" to access the Wi-Fi control interface.

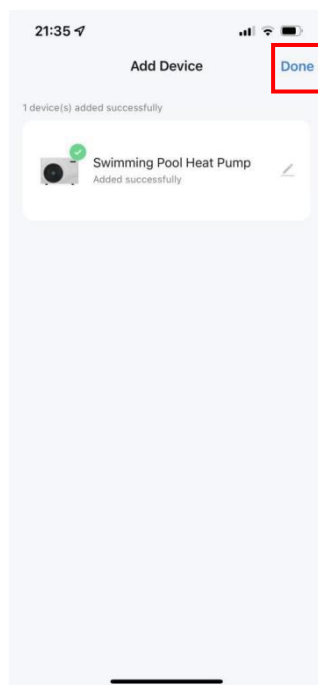

Scene 2:

If the icon  flashes rapidly, tap the following “Blink Quickly” button on your mobile phone.

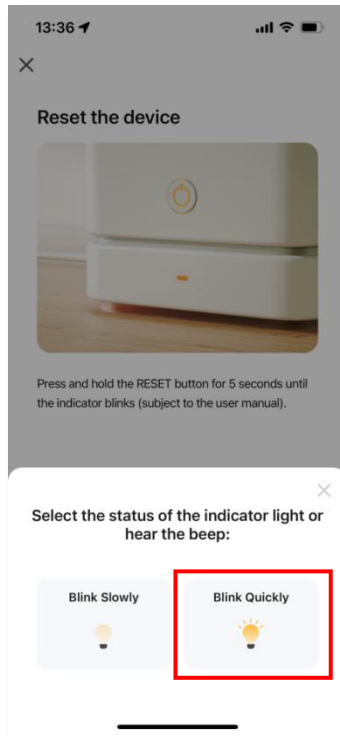

Then tap the following button “+” in the new interface. After the connection is successful, tap on the button "Done" to access the Wi-Fi control interface.

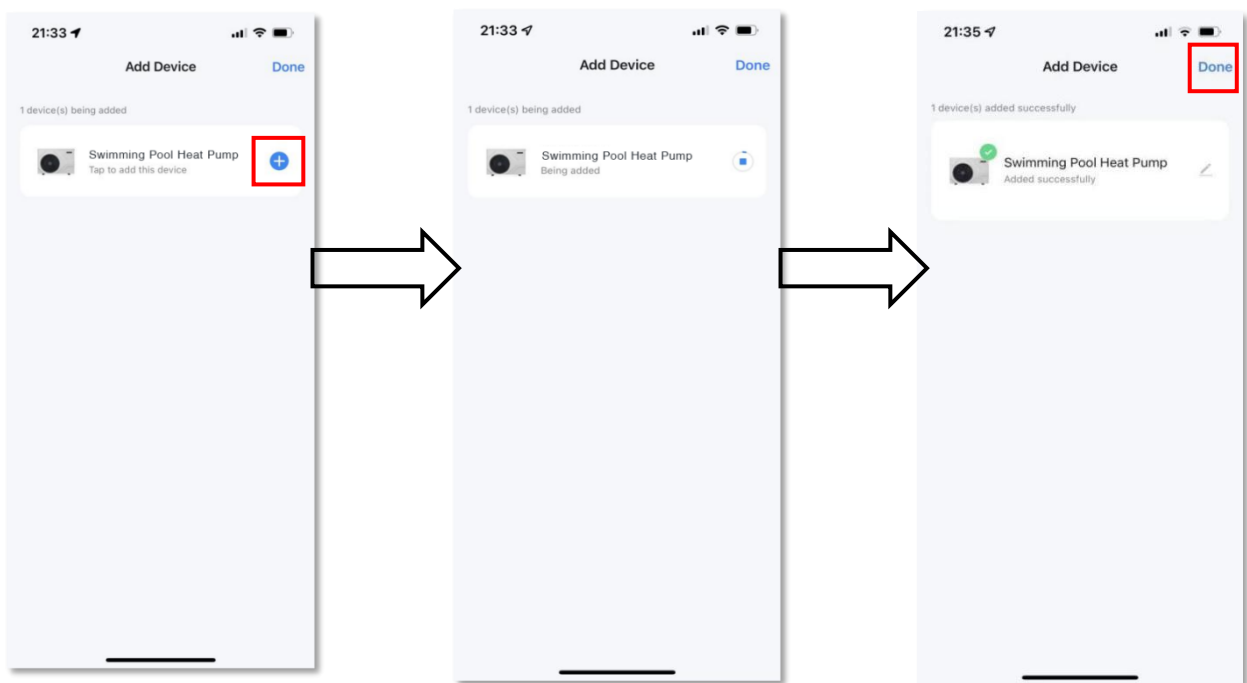

10.3.6. Wi-Fi Control Interface

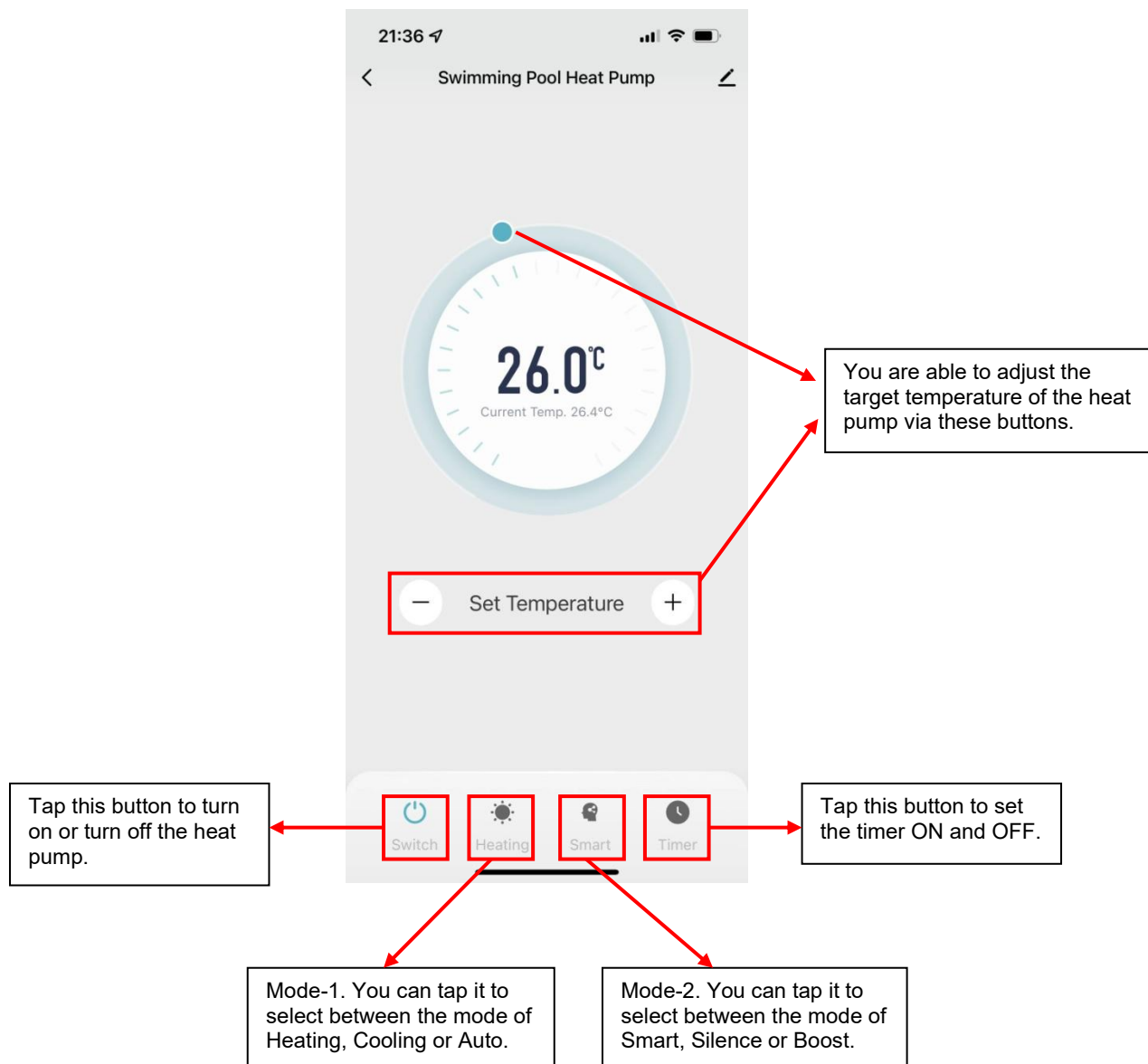

10.3.7. Share Device to Your Family Members

After the connection is established, if other family members wish to control the heat pump as well, they are required to register for "Smart Life" initially. Subsequently, the administrator can follow the steps below to share the device:

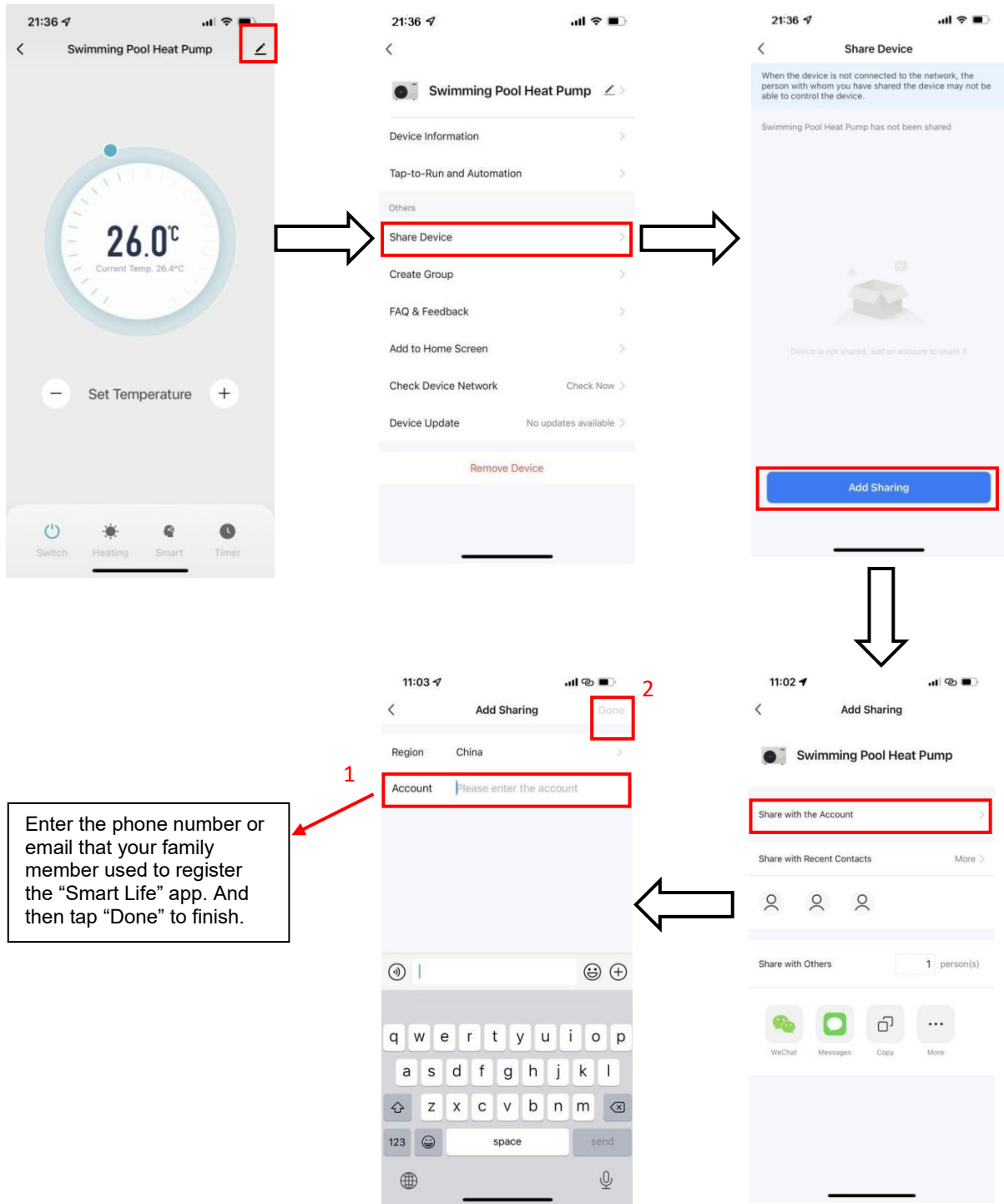

Remark: The app is subject to updates without notice.

11. MAINTENANCE

Warning: Before maintaining the equipment, make sure the power supply is turned off.

11.1. Cleaning

- a. Do not use a hard brush to scrub the surface of the machine.
- b. Use household cleaners or water to clean the machine. Do not use gasoline, thinner or any similar fuel.
- c. Do not obstruct the air intake on the condensing fin coil or the cold air discharge on the front fan.
- d. If required, clean the condensing fin coil with a soft banister brush.

11.2. Inspection

The following checks should be performed regularly:

- a. Clean the pool and filter system to avoid dirty or clogged filters that could damage the unit.
- b. The water supply system should be checked to avoid air entering the water system and low water flow, which would reduce the performance and reliability of the unit.
- c. Check and confirm that there is enough water flow before starting the unit again.

The following operations must be performed by qualified personnel at least once a year:

- a. Check for refrigerant leaks.
- b. Check the connections and integrity of the wires.
- c. Check that the machine is still grounded.
- d. Check if there is any abnormal sound when the device is running.
- e. Check for loose bolts and screws.

11.3. Winterizing

When not swimming in winter:

- a. Cut off the power supply to prevent damage to the equipment.
- b. Drain the water in the machine: Unscrew the water joint of the water inlet pipe and let the water flow out. (The water in the machine freezing in winter may damage the titanium heat exchanger.)
- c. Keep your heat pump covered with a winter cover when not in use.

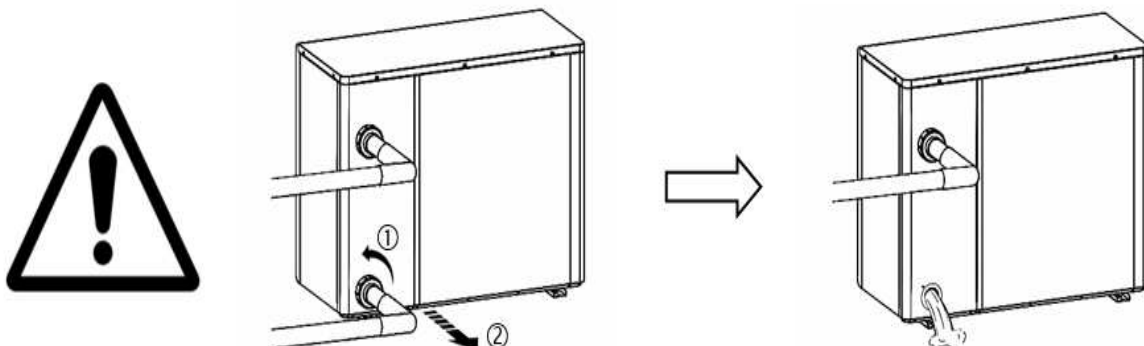

12. EXPLODED VIEW

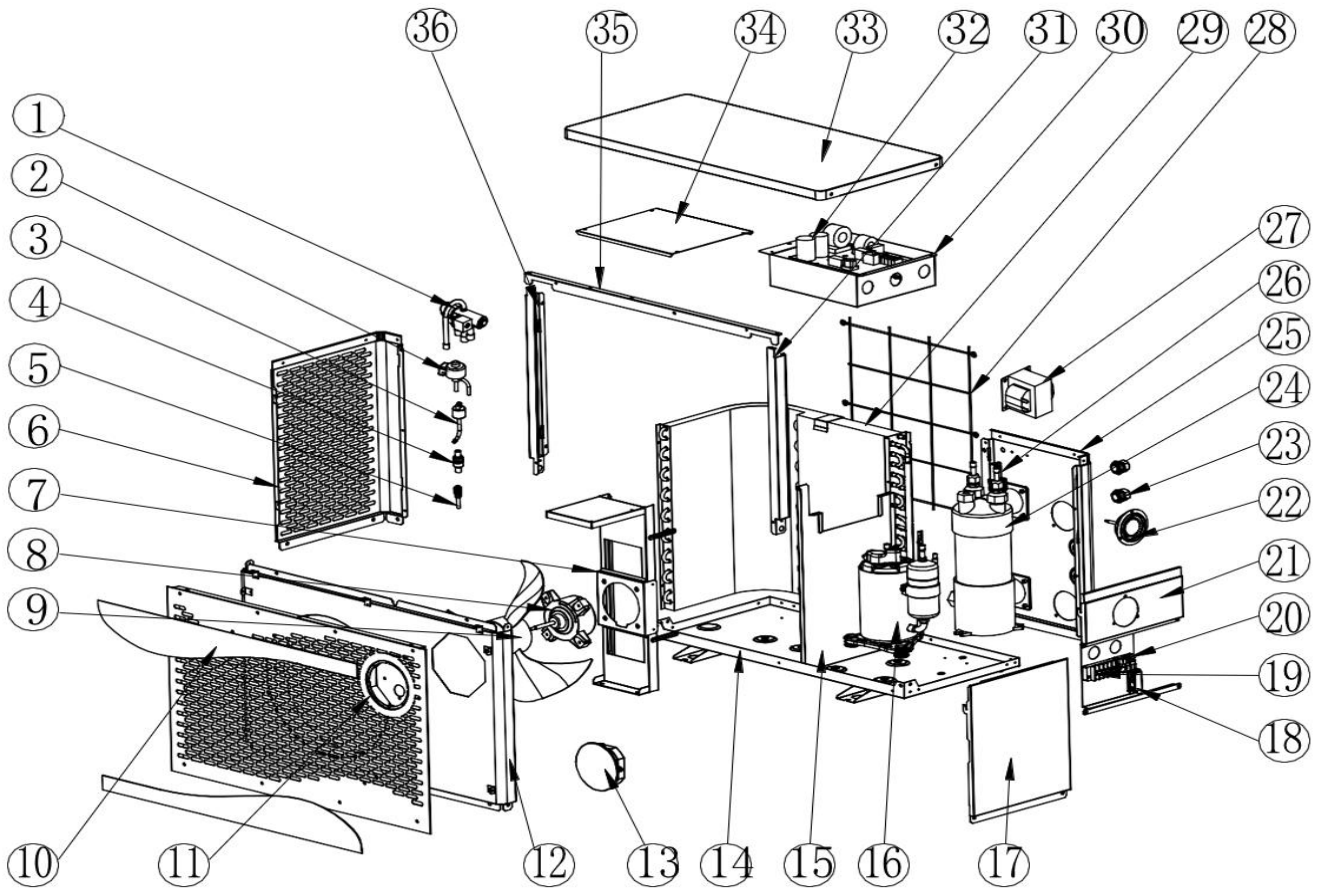

No.	Name	No.	Name
1	4-ways Valve	19	5-pole Terminal Block
2	EEV	20	2-pole Terminal Block
3	Pressure Switch	21	Right Top Panel
4	Filter	22	Pressure Gauge
5	Service Valve	23	PG Glands
6	Left Panel	24	Titanium Heat Exchanger
7	Fan Support	25	Rear Right Panel
8	Fan Motor	26	Flow Switch
9	Fan Blade	27	Reactor
10	Decorative Panel 1	28	Back Mesh
11	Decorative Panel 2	29	Fin Heat Exchanger
12	Front Panel	30	PCB Box
13	Touch Pad	31	Front Right Pillar
14	Chassiss	32	Mother Board
15	Partition Plate	33	Top Cover
16	Compressor	34	PCB Box Cover
17	Bottom Right Panel	35	Support Beam
18	Wire Clamp	36	Front Left Pillar

13. ADJUSTING AND INITIAL OPERATION

13.1 Preparation Before Adjustment

- Check that the system is installed correctly.
- Pipes and cables are connected correctly.
- Check that accessories are installed.
- Make sure the drainage is working properly.
- Make sure the system piping and connections are properly insulated.
- Check that ground/earth connection had been made correctly.
- Check that supply voltage can meet the requirement of rated voltage.
- Check that air inlet and outlet are working correctly.
- Check that the electrical leakage protector works correctly.

13.2 Adjustment Process

- Check that switch of display controller works properly.
- Check that function keys on display controller work properly.
- Check that indicator lights work properly.
- Check that drainage works properly.
- Check that system works correctly after starting up.
- Check that water outlet temperature is acceptable.
- Check if there are vibrations or abnormal sounds when the system is functioning.
- Check if the wind, noise and condensate water produced by the system affect the surrounding environment.
- Check if there is any refrigerant leakage.
- If any fault occurs, please check the instructions first to analyze and remove the fault.

14. OPERATION AND MAINTENANCE

14.1 The heat pump should be installed in accordance with AS5352:2022 SWIMMING POOL HEAT PUMP SYSTEMS. To ensure the continued correct functioning of the system it is recommended that it should be checked and maintenance should be carried once a year. During maintenance, please pay attention to the points below.

- Check that all parameters are normal during system operation.
- Check for loose electrical connections and fix if necessary.
- Check electrical components and replace if necessary.
- After prolonged use, there may be calcium or other mineral substances deposited on the surface of the condensing fin coil. This could affect the performance of the heat pump and lead to higher than normal electrical consumption, increased discharge pressure and reduced suction pressure. We recommend, cleaning the condensing fin coil with approved products such as: ***evaporator coil cleaner***.
- Any dirt accumulated on the surface of the evaporator fins should be blown away using a blower or an air compressor – **alternatively you can contact Green Star Solutions for an annual service and clean.**
- After restarting the unit following a long period of inactivity, please do the following: examine and clean the equipment carefully, clean the water pipe system, check the water pump and fasten all the wire connections.
- Always use original replacement parts.

14.2 Refrigerant

Check the refrigerant filling condition by reading the data of the liquid level from the display screen, and also by checking the air suction and exhaust pressure. If there is a leakage or any components of the refrigeration circulation system have been changed, it is necessary to check the air tightness before anything else.

14.3 Leak Detection and Air Tightness Testing

During leak detection and air tightness experiment, never allow oxygen, ethane or other harmful flammable gases to enter the system: only compressed air, fluoride or refrigerant can be used for such a test.

14.4 To Remove the Compressor, please do the following:

- Turn off the power supply.
- Remove the refrigerant from the low pressure end; make sure you reduce the exhaust speed, and avoid leakage of frozen oil.
- Remove the compressor air suction and exhaust pipe.
- Remove the compressor power cables.
- Remove the compressor fixing screws.
- Remove the compressor.

14.5 Conduct regular maintenance according to the user manual instruction, to make sure the unit running is in good condition.

- If there is a fire, disconnect the power immediately and put the fire out with fire extinguisher.
- The unit's operating environment should be free of gasoline, ethyl alcohol and other flammable materials to avoid explosions or fire.
- Malfunction: if any malfunction occurs, find the reason, fix it and then reboot the unit. Never reboot the unit forcibly if the cause of the malfunction has not been eliminated. If there is refrigerant leakage or frozen liquid leakage, switch the unit off. If it is not possible to turn the unit off from the controller then disconnect the main power supply.
- Never short connect the wire for device protection otherwise, in case unit malfunction, the unit will not be protected normally and could be damaged.
- ***Any Refrigeration Works on the Heat Pump must be carried out by a licensed refrigeration mechanic only – failure to adhere to this could damage the heat pump and void warranty.***

15. FAULT ANALYSIS AND ELIMINATION METHOD

Fault	Possible Cause	Detection and elimination method
Discharge pressure is too high.	<ul style="list-style-type: none"> • Air or non-condensable gases in system • Heat exchanger scaling/blockage • Insufficient circulation water • Excessive refrigerant charge 	<ul style="list-style-type: none"> • Vent air from heat exchanger • Clean/descale heat exchanger • Inspect water system and pump • Remove excess refrigerant
Discharge pressure is too low	<ul style="list-style-type: none"> • Liquid refrigerant entering compressor (oil foaming) • Suction pressure too low • Low refrigerant charge; air entering liquid line 	<ul style="list-style-type: none"> • Adjust expansion valve; ensure sensing bulb is insulated • Refer to 'Refrigerant Filling – Suction Pressure Too Low'
Suction pressure is too high	<ul style="list-style-type: none"> • Discharge pressure too high • Excessive refrigerant charge • Liquid refrigerant entering compressor 	<ul style="list-style-type: none"> • Remove excess refrigerant • Adjust expansion valve and insulate sensing bulb
Compressor stops due to high-pressure protection.	<ul style="list-style-type: none"> • High water inlet temperature; insufficient water flow • Incorrect high-pressure setting • Excess refrigerant charge 	<ul style="list-style-type: none"> • Inspect water system and pump • Check high-pressure switch • Remove excess refrigerant
Compressor stops due to motor overload	<ul style="list-style-type: none"> • -Voltage too high/low • Abnormal discharge pressure • Mechanical loading failure • High ambient temperature • Motor/terminal short circuit 	<ul style="list-style-type: none"> • Keep voltage within $\pm 20V$ of rating • Check compressor current • Improve ventilation
Compressor stops due to built-in thermostat	<ul style="list-style-type: none"> • Voltage too high/low • Discharge pressure too high • Insufficient refrigerant 	<ul style="list-style-type: none"> • Verify voltage • Inspect discharge pressure • Check for leaks
Compressor stops due to low-voltage protection	<ul style="list-style-type: none"> • Blocked dry filter • Expansion valve failure • Insufficient refrigerant 	<ul style="list-style-type: none"> • Service/replace dry filter • Adjust/replace expansion valve • Add refrigerant
High compressor noise	<ul style="list-style-type: none"> • Liquid hammering from refrigerant entering compressor 	<ul style="list-style-type: none"> • Adjust refrigerant feed; check expansion valve and suction superheat
Compressor cannot start	<ul style="list-style-type: none"> • Over-current relay tripped; fuse blown • Control circuit disconnected • No power • Refrigerant pressure too low for switch activation • Contactor coil burnt out • Water system fault 	<ul style="list-style-type: none"> • Set control to manual and restart • Inspect control system • Check power supply • Check refrigerant charge • Reconnect/adjust wiring • Replace compressor

16. AFTER-SALE

If your heat pump does not operate normally, please turn off the unit and cut off the power supply at once, then contact our service center or technical department.

Contact Details

GREENSTAR SOLUTIONS

3/30 HINES ROAD O'CONNOR 6163

08 93313868

admin@greenstarsolutions.net.au

service@greenstarsolutions.net.au

17. WARRANTIES AND LIMITATION OF LIABILITY

WARRANTIES AND LIMITATION OF LIABILITY

We set out below what our warranty (**Product Warranty**) is in relation to the components (**Component**) of our pool heating system (Genesis™- Next Generation Heat Pump™) (**Product**) and our services (**Services Warranty**) in respect of initially installing our Product (**Services**) the period of time for which these warranties apply (**Warranty Period**) and all the information you need to know about making a claim. We also set out what the limitations on our liability are should you purchase a Product from us or should we render a Service to you. If you have any questions for us, please reach out using the contact details below!

Who is this Agreement Between?

This agreement (**Agreement**) is between Doncon & Co Pty Ltd Pty Ltd T/A Green Star Solutions ABN 51 164 532 870 (**we, us or our**) and you, the person or entity that has purchased Product from us (as specified below), together the **Parties** and each a **Party**. This Agreement forms part of such terms and conditions as may apply to the sale of our products from time to time.

You accept this Agreement by instructing us (whether orally or in writing) to proceed with the supply of the Product, or making payment or part-payment to us in respect thereof.

Your Consumer Law Rights

Certain legislation, including the Australian Consumer Law, and similar consumer protection laws and regulations, may confer you with rights, warranties, guarantees and remedies relating to the supply of the Product by us to you which cannot be excluded, restricted or modified (**Consumer Law Rights**). The benefits given to you under this warranty are in addition to, and do not limit or derogate, your rights and remedies at law in relation to any products you have purchased from us, or services that you have received from us, including under the Australian Consumer Law within the *Competition and Consumer Act 2010* (CAA).

Our goods and services come with guarantees that cannot be excluded under the Australian Consumer Law. For major failures with the service, you are entitled:

- to cancel your service contract with us; and
- to a refund for the unused portion, or to compensation for its reduced value.

You are also entitled to choose a refund or replacement for major failures with goods. If a failure with the goods or a service does not amount to a major failure, you are entitled to have the failure rectified in a reasonable time. If this is not done you are entitled to a refund for the goods and to cancel the contract for the service and obtain a refund of any unused portion. You are also entitled to be compensated for any other reasonably foreseeable loss or damage from a failure in the goods or service.

Consumer guarantees (under the Australian Consumer Law) have no set time limit but generally last for an amount of time that is reasonable to expect, given factors such as the cost and quality of the Product or any representations made. Full details of your consumer rights, including what is considered a major failure, may be found at www.consumerlaw.gov.au.

What Products our Product Warranty Applies to

Our Product Warranty applies to the following:

Component	Warranty Period <i>(commencing on the date of purchase)</i>
Titanium Heat Exchanger	30 years pro-rata basis for residential installations.
Compressor	10 years pro-rata basis for residential installations.
Evaporator	3 years pro-rata basis for residential installations.
All other heat pump components	3 years for residential installations.
Genesis Link Automatic Controller	2 years for residential installations.
Genesis Switch Automatic Controller	2 years for residential installations.
Circulation pump	3 years for residential installations.

When the Product Warranty Applies

If during the Warranty Period, there is a fault or defect in the functionality of the Product or a Component as a result of our default (**Defect**), then we will use our best endeavours to remedy the Defect at our cost, save as otherwise set out herein.

Services Warranty

Subject to the terms of this Warranty, if during the first 12 months from the date of purchase of the Services from us the Services prove defective by reason of improper workmanship or materials (**Services Defect**), and if we determine that your claim under this warranty is successful in terms of this Warranty, we will resupply the Services. Your Consumer Law Rights may extend beyond the Warranty Period.

How to Claim Under our Product Warranty and Services Warranty

To make a claim under this warranty, you must notify us by email as soon as you become aware of the Defect and/or Services Defect, and in any event, within 1 month of when you become aware of the Defect and/or Services Defect, and include the following information in your email:

- your invoice number, if applicable;
- the serial number displayed on the Product or relevant Component;
- the date of installation of the Product; and
- a detailed description of the issue with the Product or Component.

You must work with our support team and provide any other information we reasonably require to assess your claim. We will notify you of our determination as to whether your claim is valid under this warranty and any determination we make will be final and binding.

If your Claim under our Product Warranty is Successful

Subject to your rights and remedies under the Australian Consumer law, if we determine your claim under this warranty is successful, we may, in our discretion, elect to:

- repair the Product or the relevant Component;
- pay you an amount as determined by us for the cost of repairing the Product or the relevant Component;
- replace the Product or Component;
- supply to you an equivalent Product;
- pay you an amount as determined by us for the cost of replacing the Product or the relevant Component; or
- pay you an amount as determined by us for the cost of acquiring an equivalent Product.

To the maximum extent permitted by law, the remedies above will be your sole and exclusive remedy in relation to the Defect.

If any materials, parts or features required to facilitate any repair or replacement are unavailable or no longer in production, or your model of Product or Component is no longer available or in production, we will either use our best endeavours to repair the Product or Component using appropriate equivalent materials, parts or features, replace the Product or Component with an appropriate equivalent model or provide you with a full or partial refund, as required, and as determined by us in our sole discretion. If the defective part of the Product is not essential to the functionality of the Product, then we may issue a partial refund to you.

This warranty only sets out the Warranty Period within which we will offer you a repair, refund or replacement. Your rights under the Australian Consumer Law may extend beyond the Warranty Period.

Costs

Our labour, travel and freight costs incurred as a result of attending to remedy a Defect or Services Defect are excluded after a period of 12 months. These costs are to be paid by you. Your failure to make payment in respect of these costs on or before the date of our invoice to you in respect hereof will void the Product Warranty or the Services Warranty, as applicable.

To the extent that it is determined by us, acting reasonably, that the Product, a Component, or our Services in respect of which you have sought to exercise your rights under a Product Warranty or Services Warranty is:

- not defective; or
- is defective as a result of the exclusions mentioned in the clause "Exclusions from our Product Warranty and Services Warranty",

Then we reserve the right to charge you at our current hourly rate for all costs incurred by us which are associated with examining the Product, including our travel and associated costs.

Exclusions from our Product Warranty and Services Warranty

To the maximum extent permitted by law, this warranty does not cover, and we will have no liability in respect of, and you waive and release us from, any liability (under this warranty or otherwise), in relation to any Defect or Services Defect which is caused (or partly caused) or contributed to, by any:

- act or omission, accident, improper cleaning, improper assembly, transportation or negligence by you or any third party not engaged by us (including any third-party installer of your Product);
- cosmetic changes that occur overtime;
- failure on your part to follow any instructions or guidelines (including any manual) provided by us or the manufacturer in relation to your Product;
- use of your Product otherwise than for any application or use specified by us or the manufacturer;
- reasonable wear and tear of your Product or any of the Components therein;
- continued use of your Product (where such use is not reasonable) after any Defect in your Product becomes apparent or would have become apparent to a reasonably prudent person;
- failure by you to notify us of any Defect in your Product within a reasonable period of time after you become aware of or ought to have reasonably become aware of the relevant Defect;
- act of God or force majeure event (including but not limited to war, riot, invasion, act of terrorism, contamination, earthquake, flood, fire, or other natural disaster, or any other event or circumstance beyond our or the manufacturer's reasonable control);
- insect or rodent ingress into the Product or its surrounds;
- repair, replacement, maintenance, or otherwise compromise of the Product by you or any person other than us, a third-party approved by us or the manufacturer; or
- damage caused by exposing the products to extreme weather conditions, harsh or adverse pool or spa water conditions, or chemicals/ agents that are known to damage the Product.

Subject to your Consumer Law Rights, we exclude all warranties, and all Products (including the Components), Services and work are provided to you without warranties of any kind, either express or implied, whether in statute, at law or on any other basis, except where expressly set out herein.

Liability

Despite anything to the contrary, to the maximum extent permitted by law:

- neither Party will be liable for consequential loss, which includes any consequential loss, indirect loss, real or anticipated loss of profit, loss of benefit, loss of revenue, loss of business, loss of goodwill, loss of opportunity, loss of savings, loss of reputation, loss of use and/or loss or corruption of data, whether under statute, contract, equity, tort (including negligence), indemnity or otherwise;
- a Party's liability for any expense, cost, liability, loss, damage, claim, notice, entitlement, investigation, demand, proceeding or judgment (whether under statute, contract, equity, tort (including negligence), indemnity or otherwise), howsoever arising, whether direct or indirect and/or whether present, unascertained, future or contingent and whether involving a third party or one of the Parties (**Liability**), will be reduced proportionately to the extent the relevant Liability was caused or contributed to by the acts or omissions of the other Party (or any of its personnel), including any failure by that other Party to mitigate its loss; and
- save for what is set out herein, our aggregate liability for any Liability arising from or in connection with our Product or Services will be limited, in our sole discretion, to us resupplying the Product, Component or Services to you, to us repaying you an amount of the price paid by you to us in respect of the supply of the Services, Product or relevant Component to which the Liability relates, or to us repaying you an amount as set out herein in respect of the supply of the Services, Product or relevant Component to which the Liability relates.

General

Delays: We will have no liability, and you waive and release us from any liability, for any delays (including any costs arising out of any delays) in providing any work or services (including repairs) under this warranty, or in assessing any claim made by you under or in relation to this warranty.

No third-party reliance: The benefit of this warranty is for you only, and no other person or third party can rely on or make a claim under this warranty. For the avoidance of doubt, if you resell the Product, this warranty will be void.

No assignment or transfer: This warranty or the benefit under this warranty cannot be assigned or transferred to any other person or third party.

Severance: If any provision (or part of it) under this warranty is held to be unenforceable or invalid in any jurisdiction, then it will be interpreted as narrowly as necessary to allow it to be enforceable or valid. If a provision (or part of it) under this warranty cannot be interpreted as narrowly as necessary to allow it to be enforceable or valid, then the provision (or part of it) must be severed from this warranty and the remaining provisions (and remaining part of the provision) of this warranty are valid and enforceable.

Jurisdiction and applicable law: This warranty is only valid and enforceable in Australia and is governed by the laws of Western Australia and the Commonwealth of Australia. Each Party to this warranty irrevocably and unconditionally submits to the exclusive jurisdiction of the courts operating in Western Australia.

What are our Contact Details?

Greenstar Solutions ABN 51164 532 870 Email:

admin@greenstarsolutions.net.au

Phone: 08 9331 3868

Address: 3/30 Hine Road, O'Connor, Western Australia 6163
